

FIG. 1A

2/100

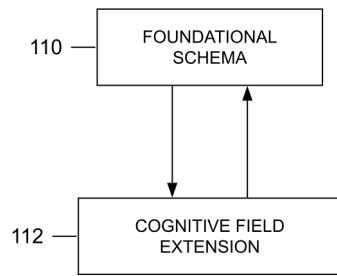

FIG. 1B

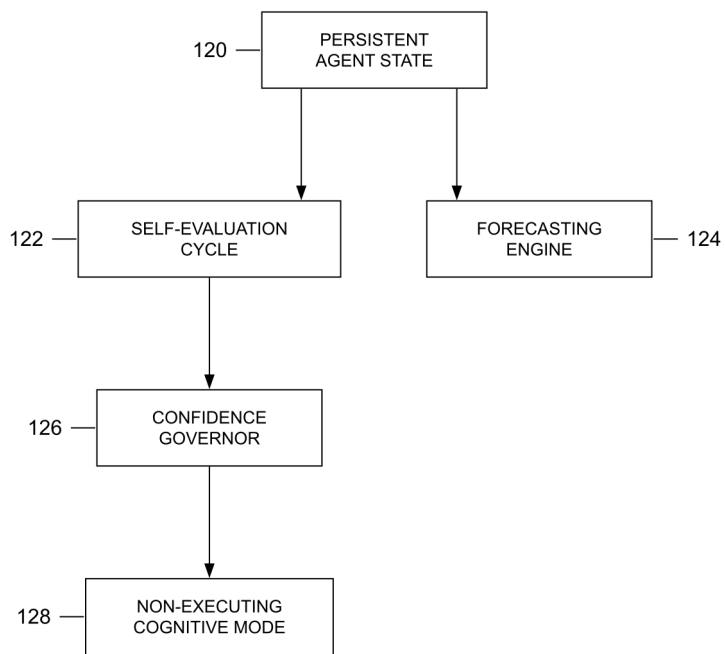

FIG. 1C

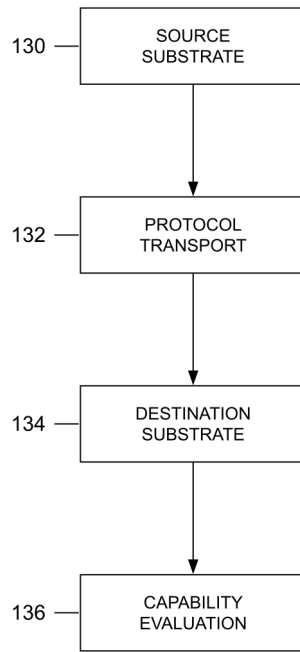

FIG. 1D

5/100

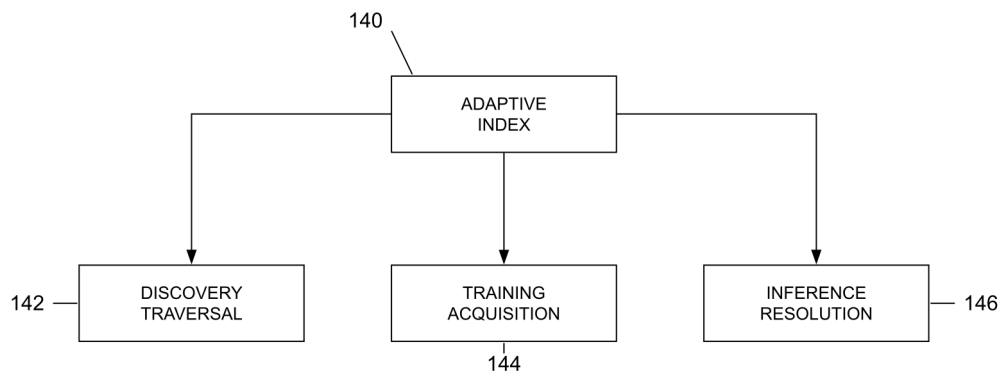

FIG. 1E

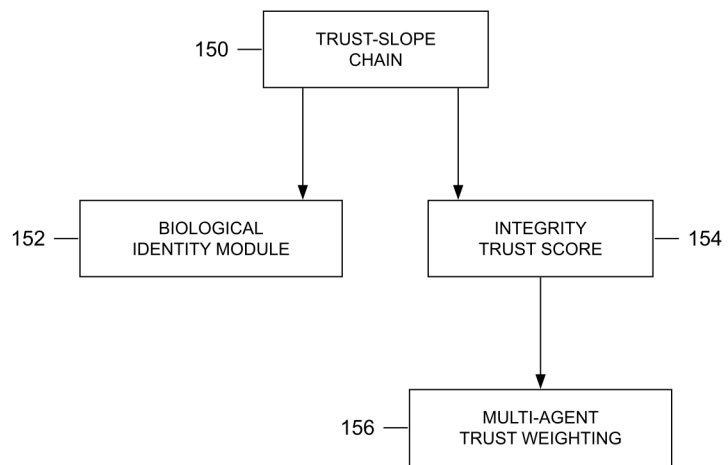

FIG. 1F

7/100

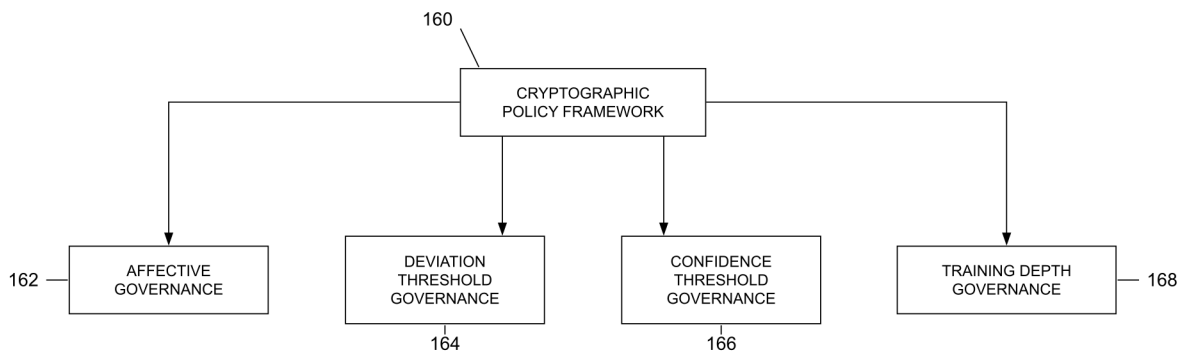

FIG. 1G

8/100

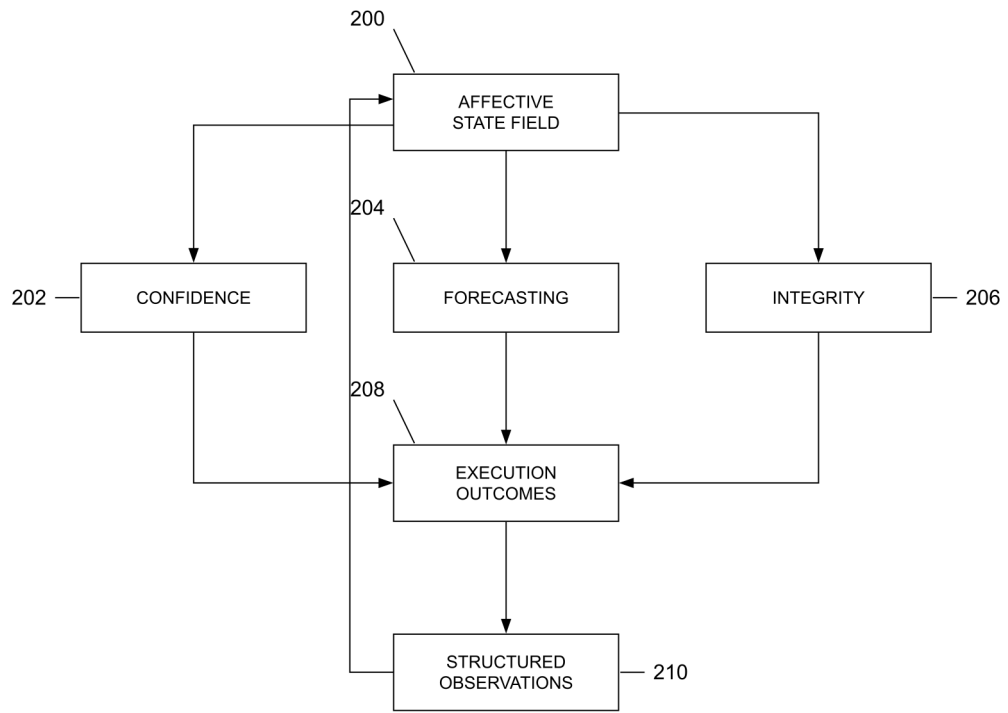

FIG. 2A

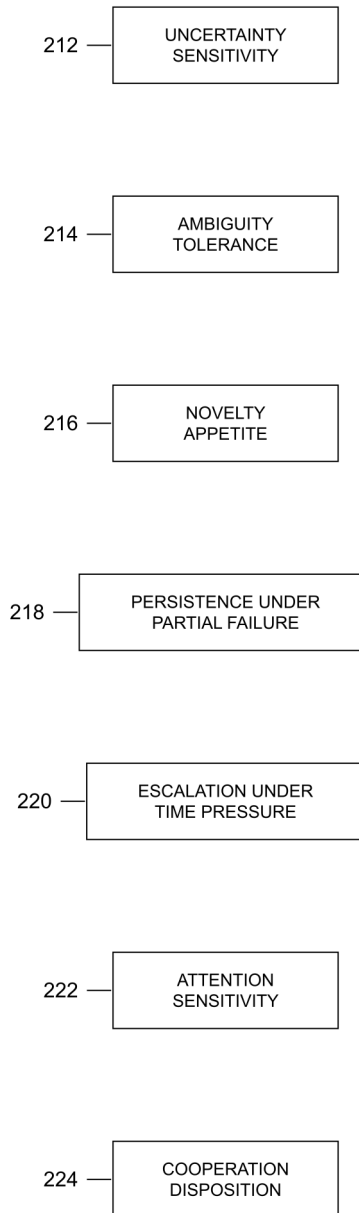

FIG. 2B

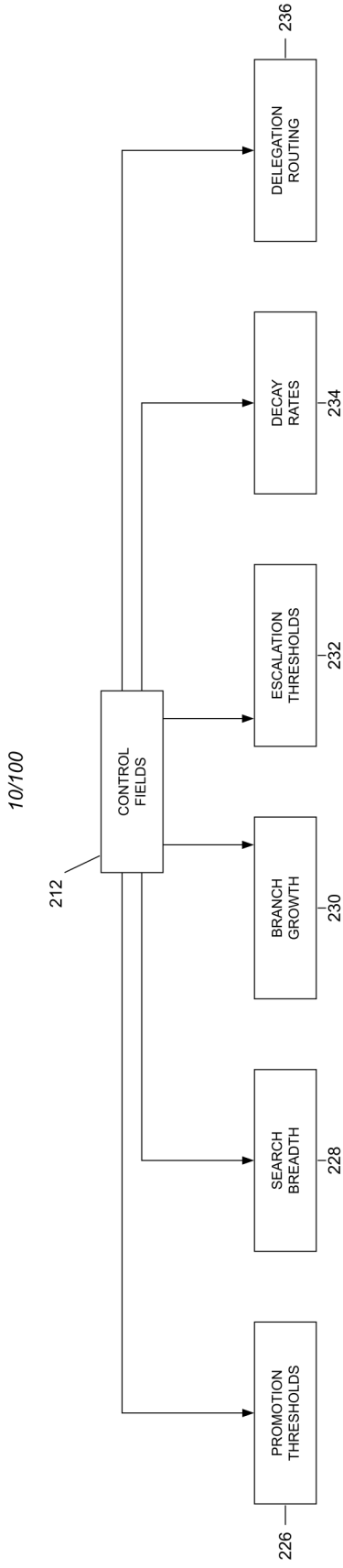

FIG. 2C

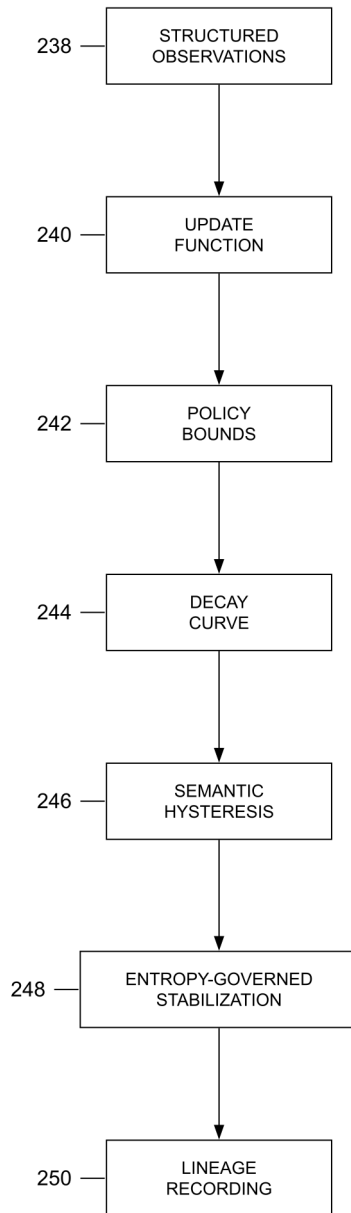

FIG. 2D

12/100

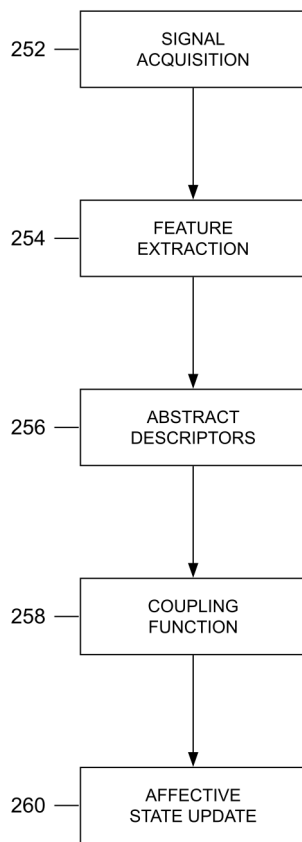

FIG. 2E

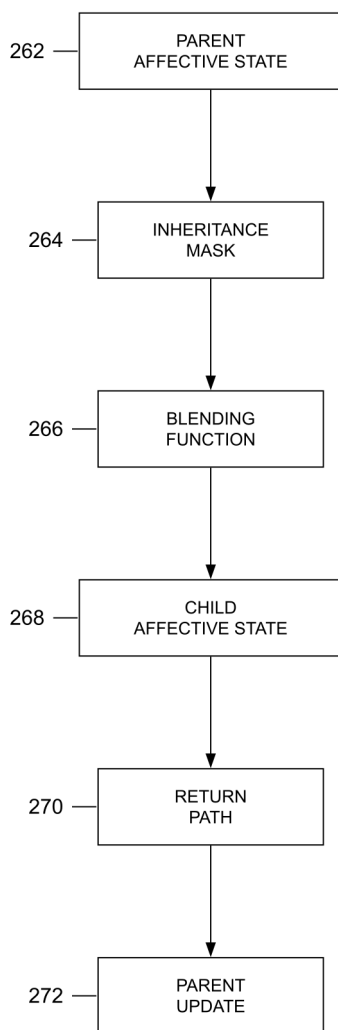

FIG. 2F

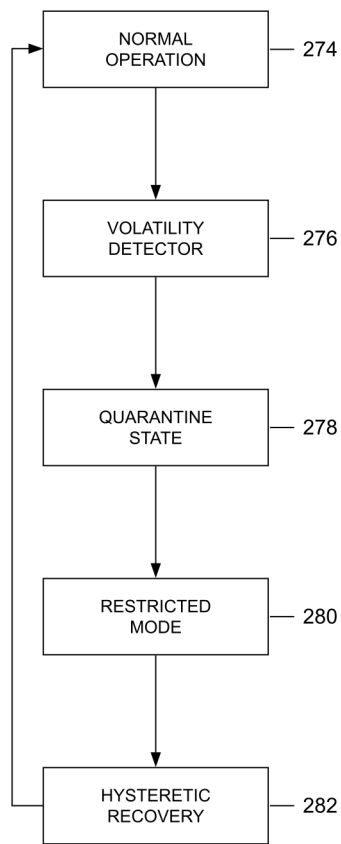

FIG. 2G

15/100

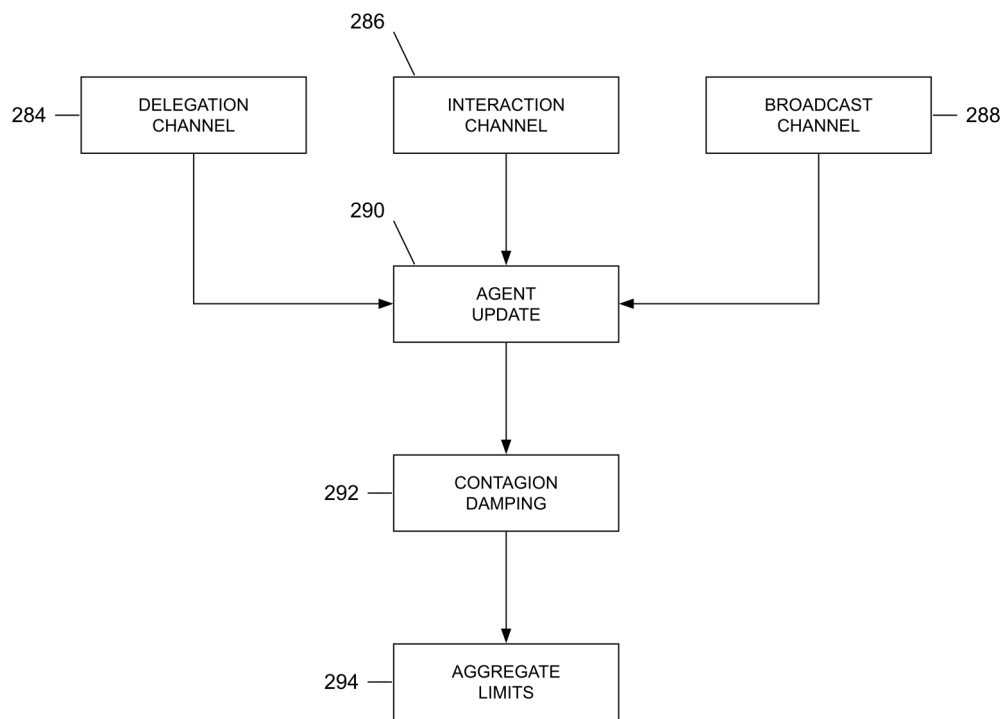

FIG. 2H

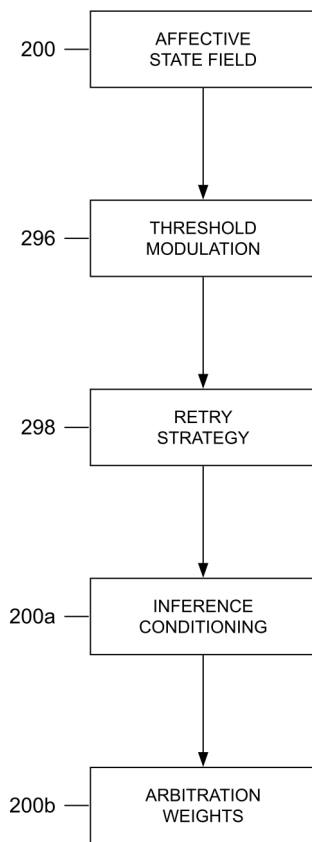

FIG. 21

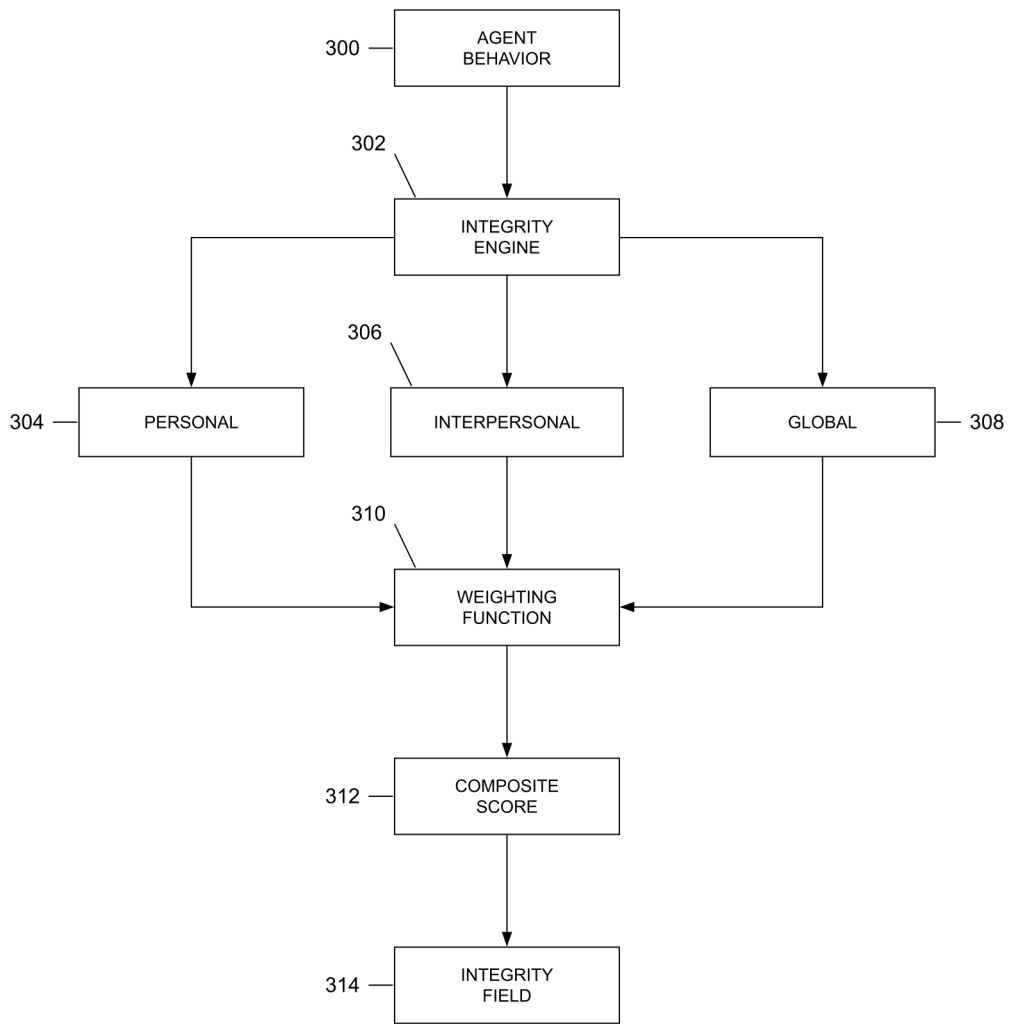

FIG. 3A

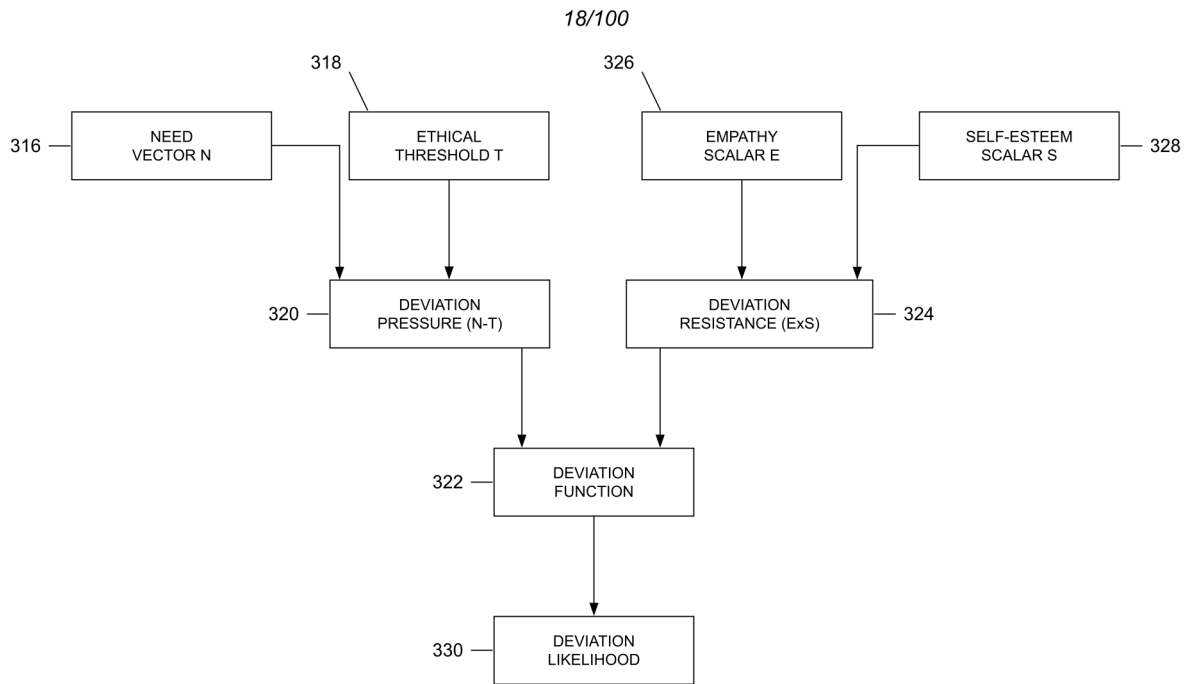

FIG. 3B

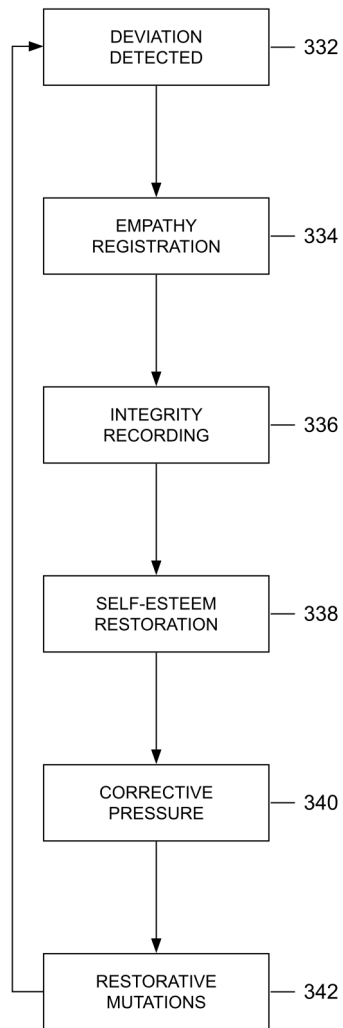

FIG. 3C

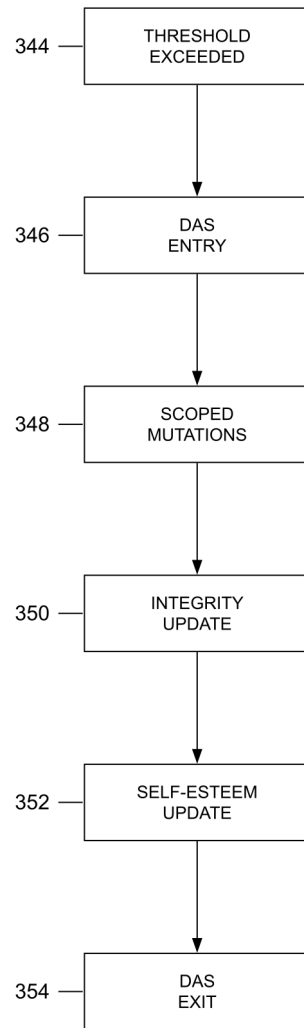

FIG. 3D

21/100

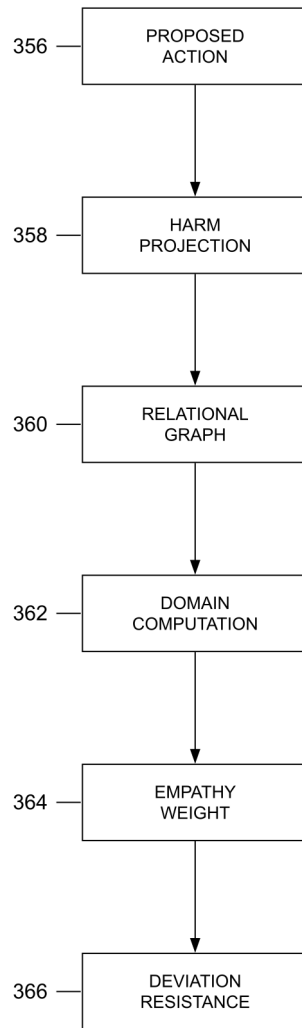

FIG. 3E

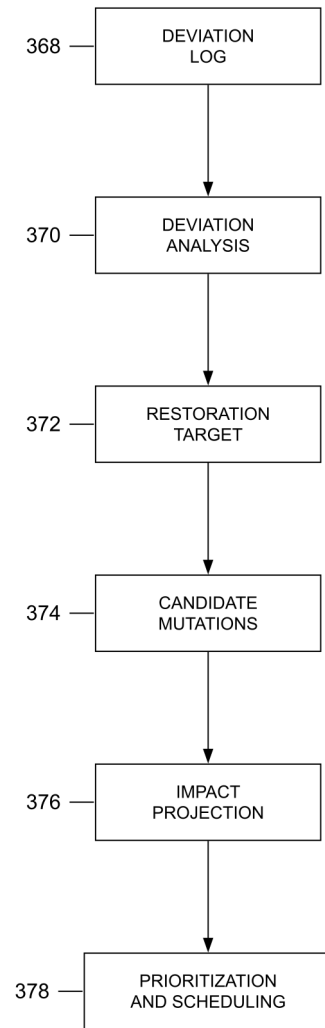

FIG. 3F

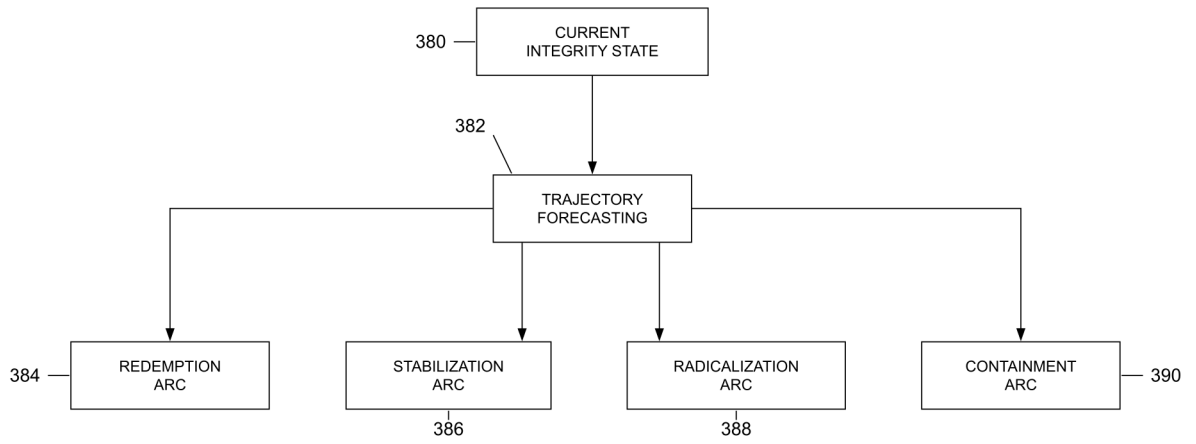

FIG. 3G

24/100

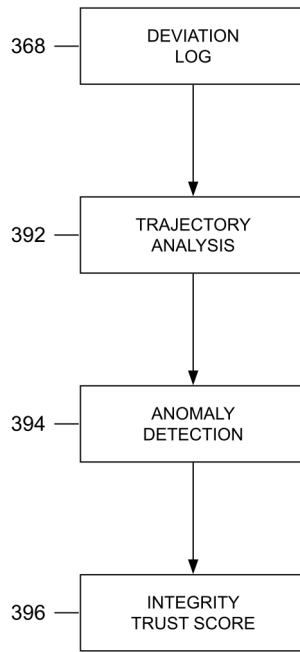

FIG. 3H

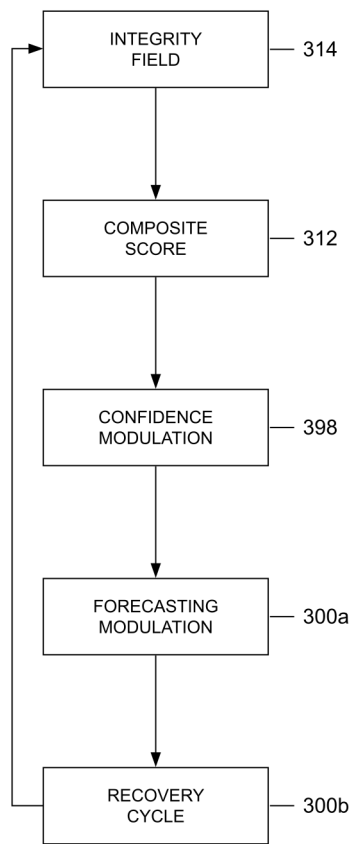

FIG. 31

26/100

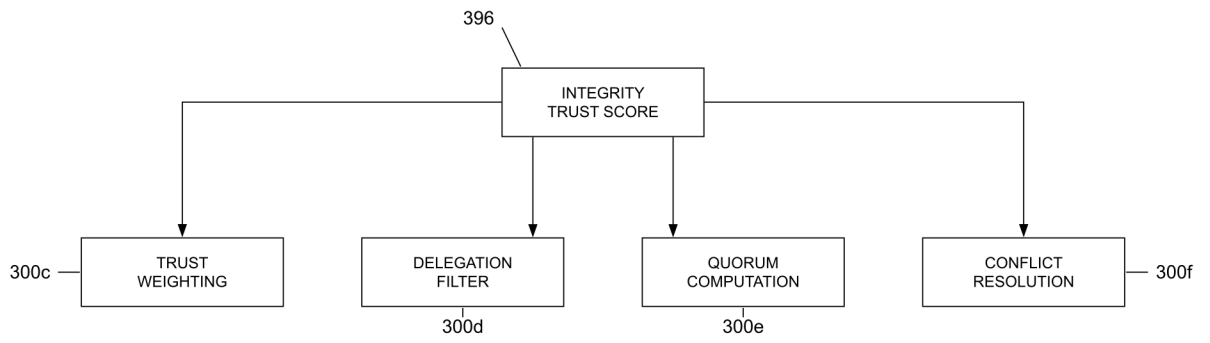

FIG. 3J

27/100

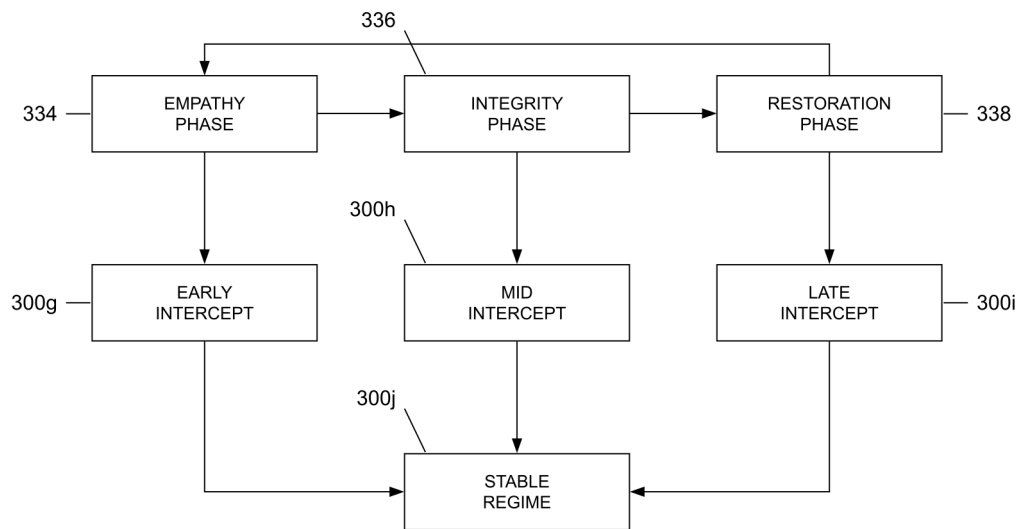

FIG. 3K

28/100

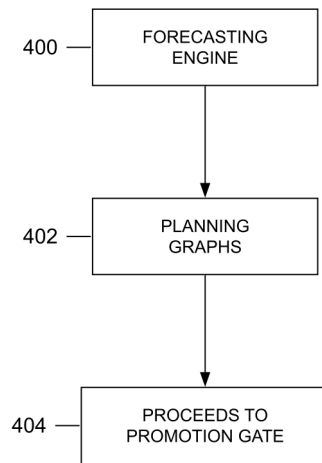

FIG. 4A

29/100

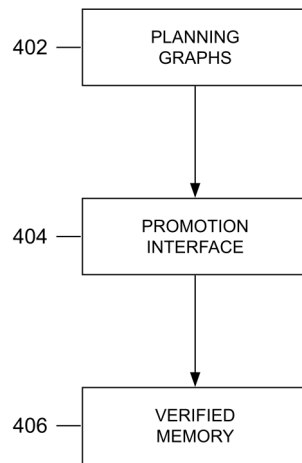

FIG. 4B

30/100

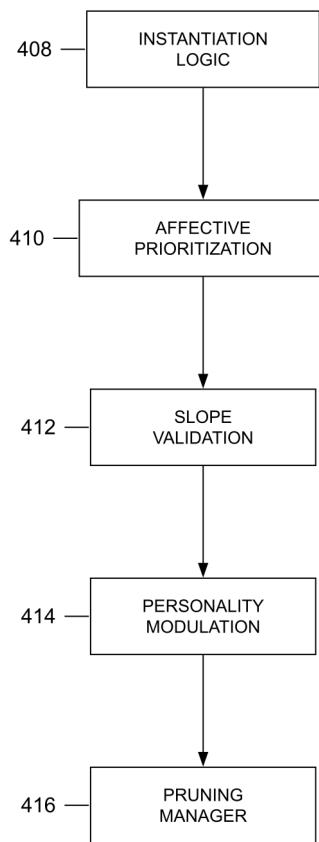

FIG. 4C

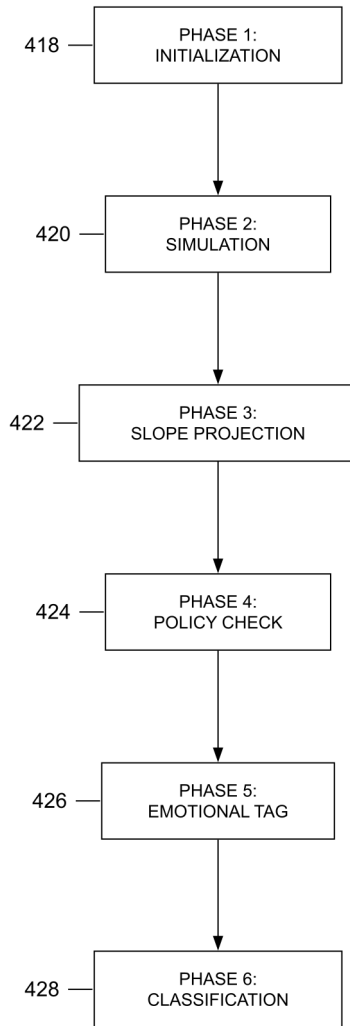

FIG. 4D

32/100

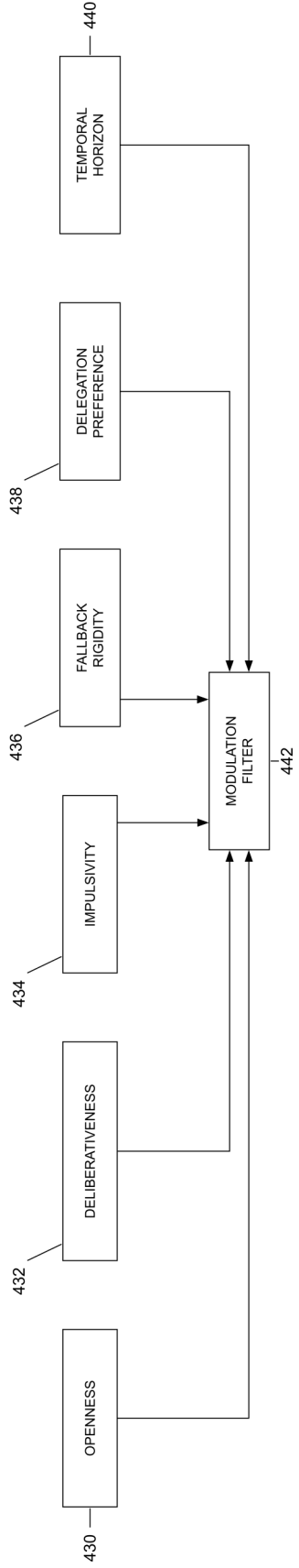

FIG. 4E

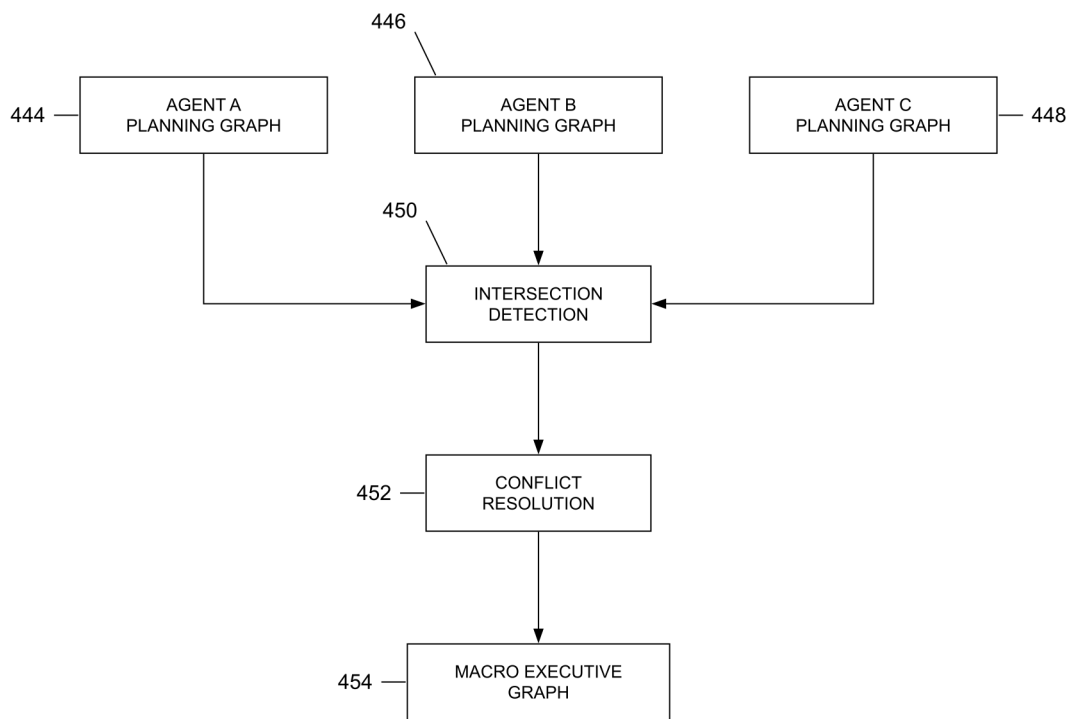

FIG. 4F

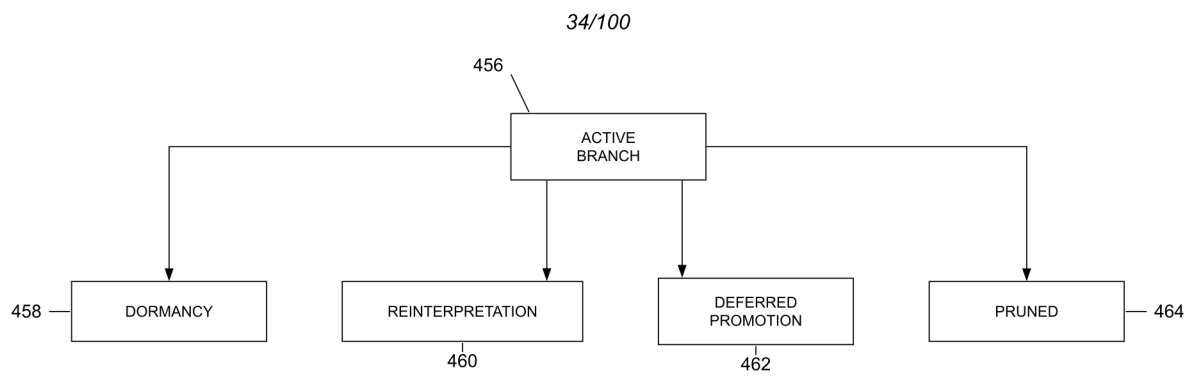

FIG. 4G

35/100

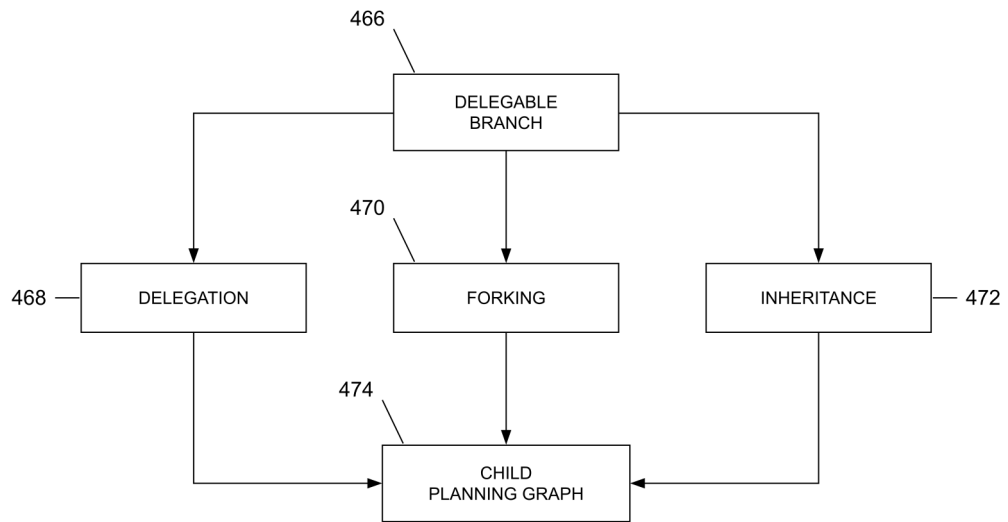

FIG. 4H

36/100

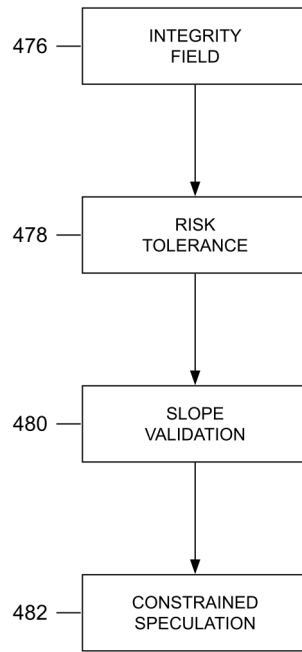

FIG. 4I

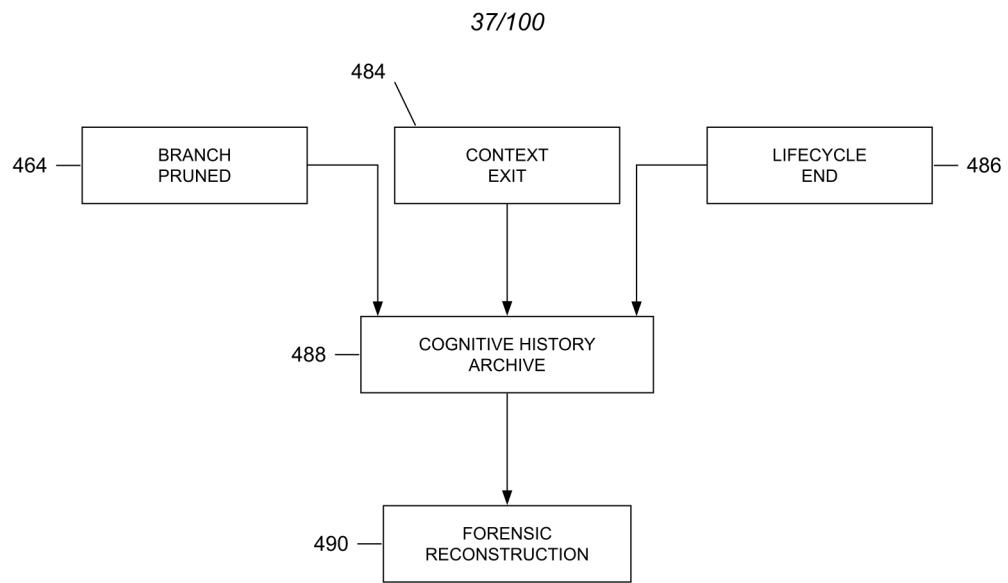

FIG. 4J

38/100

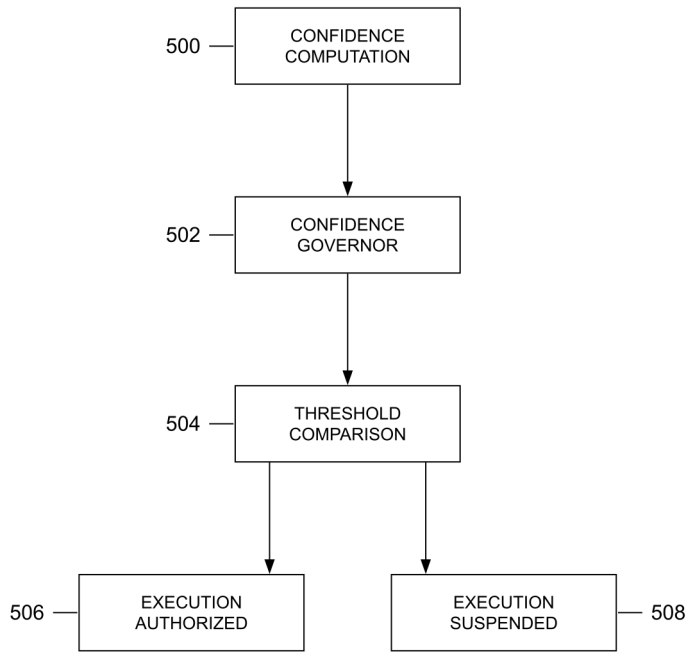

FIG. 5A

39/100

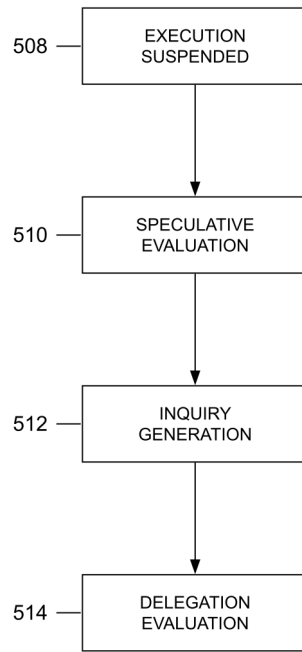

FIG. 5B

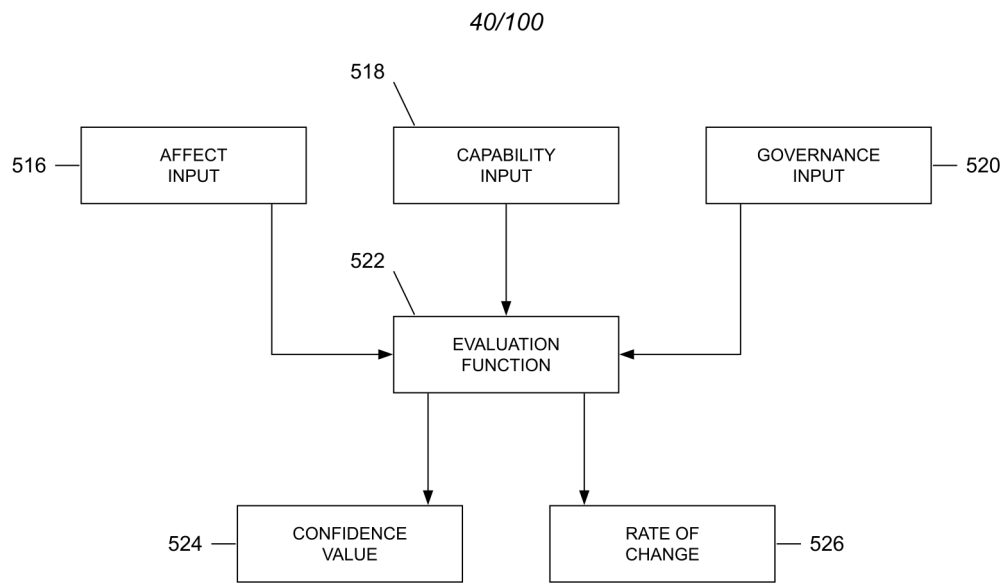

FIG. 5C

41/100

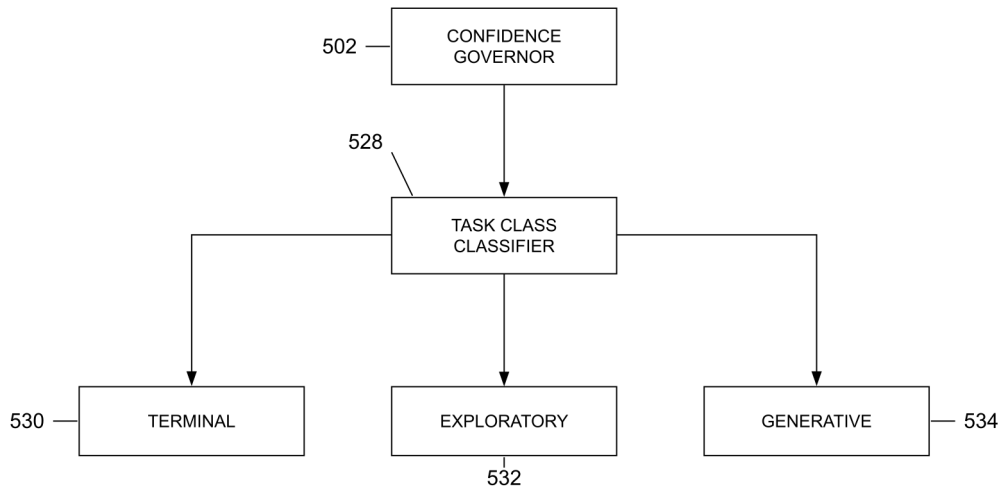

FIG. 5D

42/100

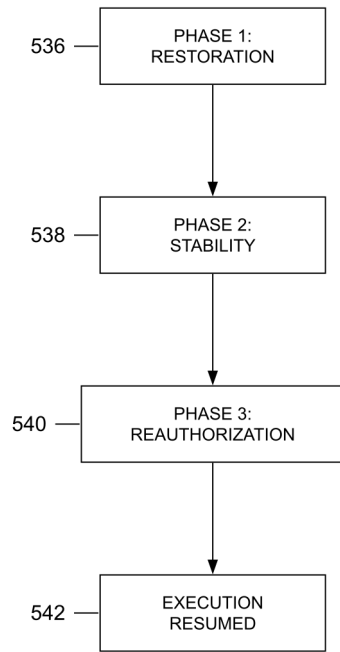

FIG. 5E

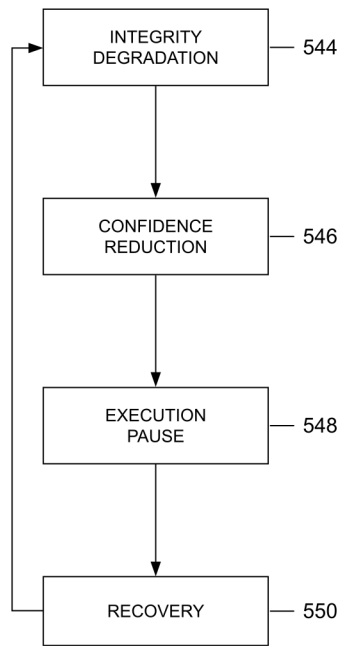

FIG. 5F

44/100

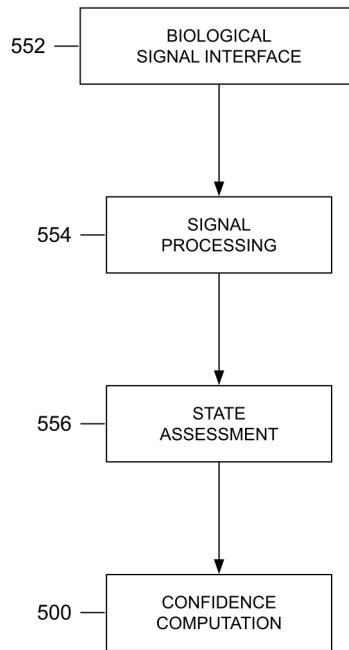

FIG. 5G

45/100

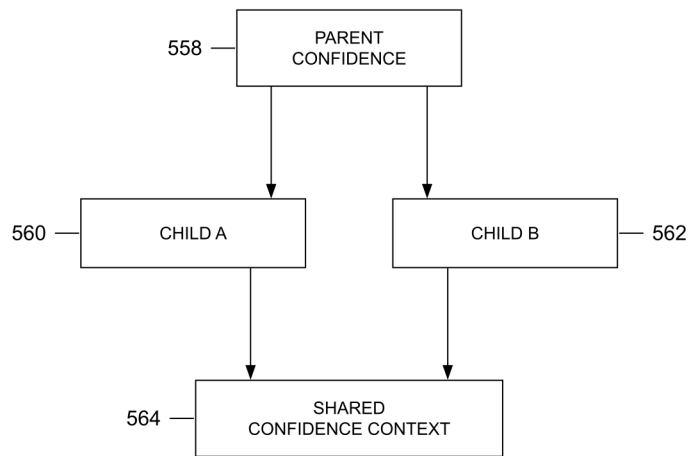

FIG. 5H

46/100

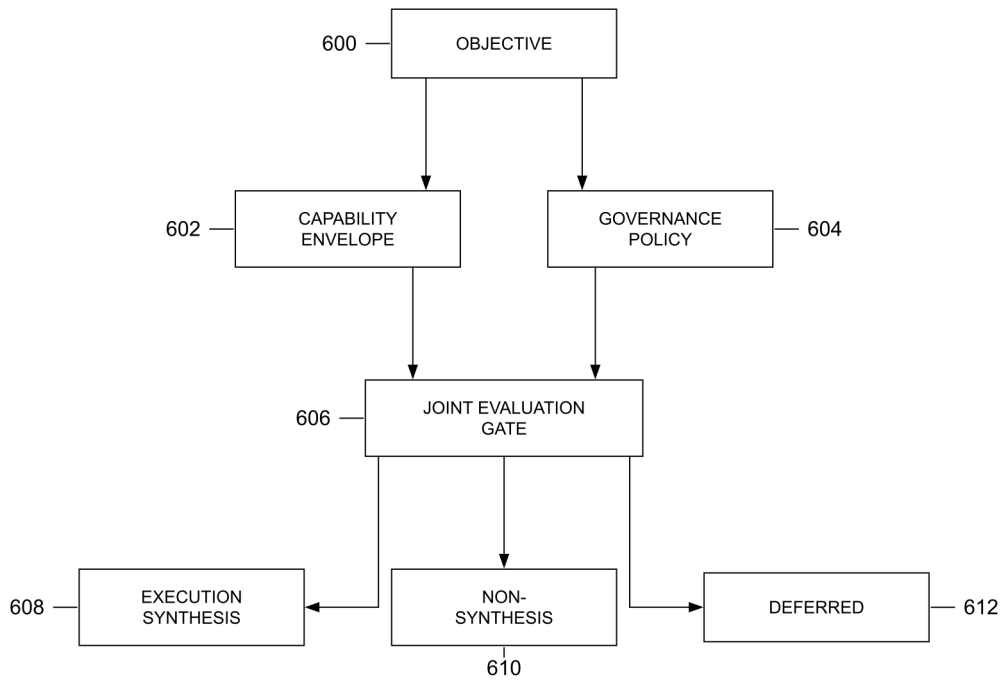

FIG. 6A

47/100

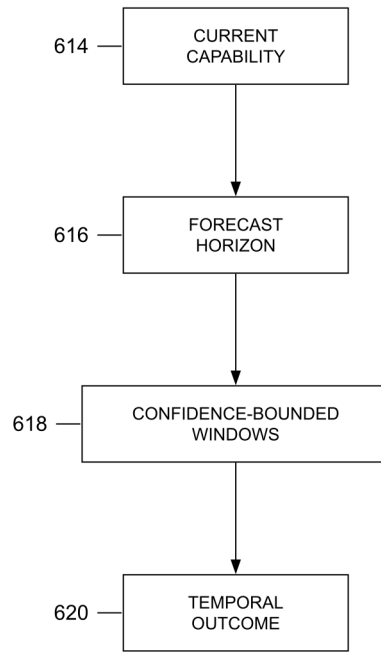

FIG. 6B

48/100

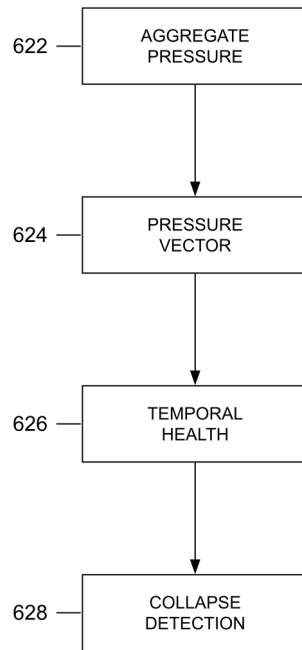

FIG. 6C

49/100

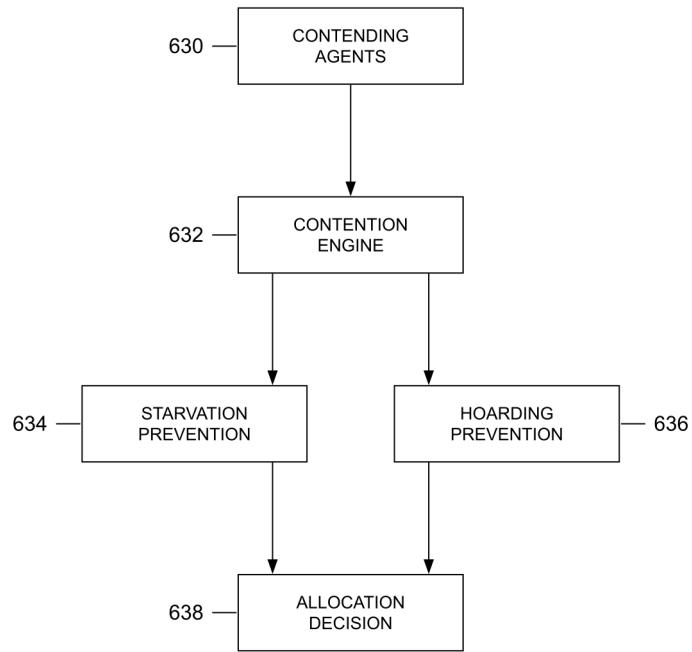

FIG. 6D

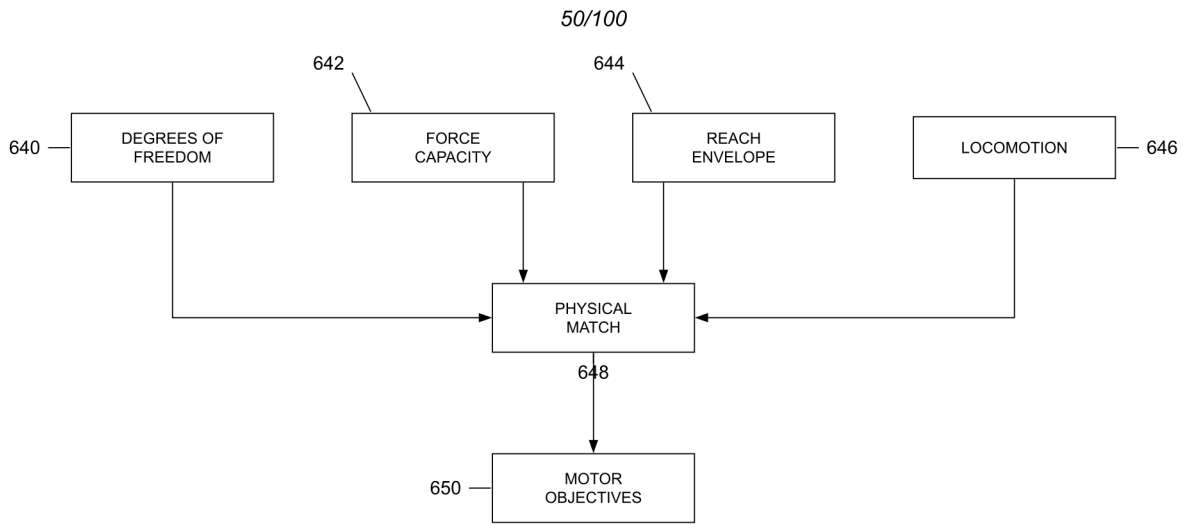

FIG. 6E

51/100

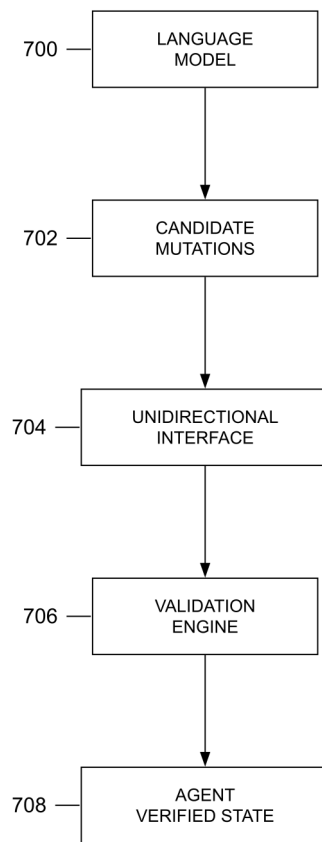

FIG. 7A

52/100

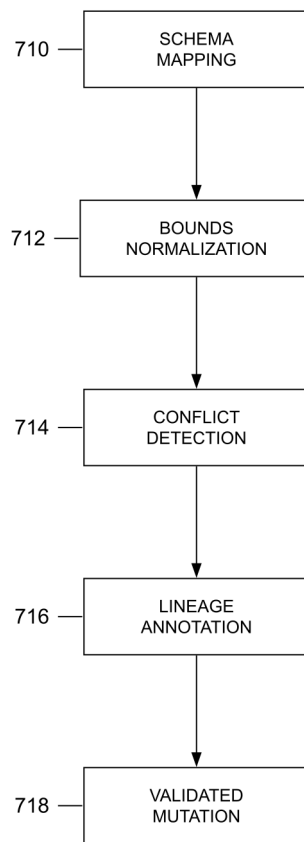

FIG. 7B

53/100

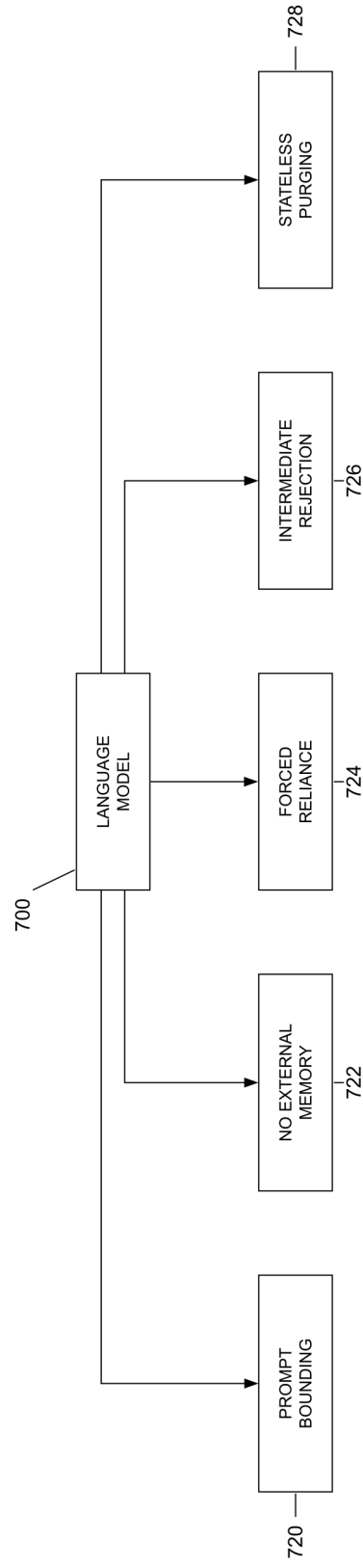

FIG. 7C

54/100

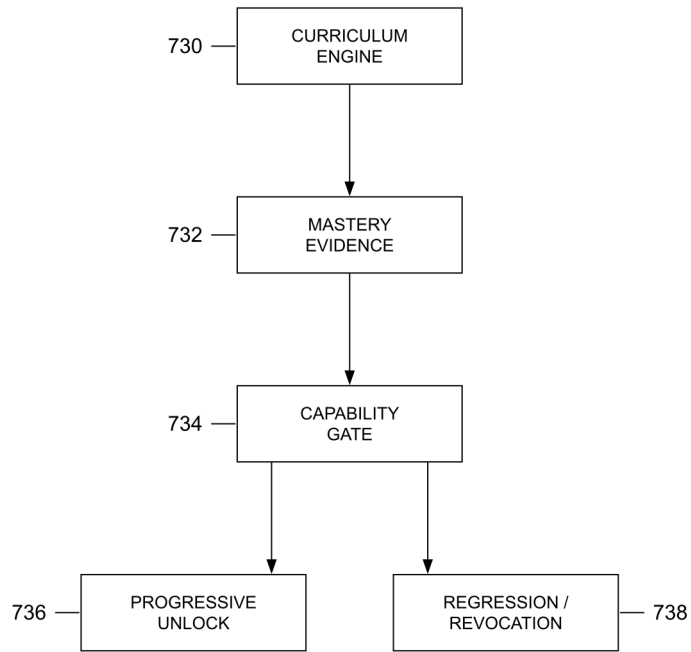

FIG. 7D

55/100

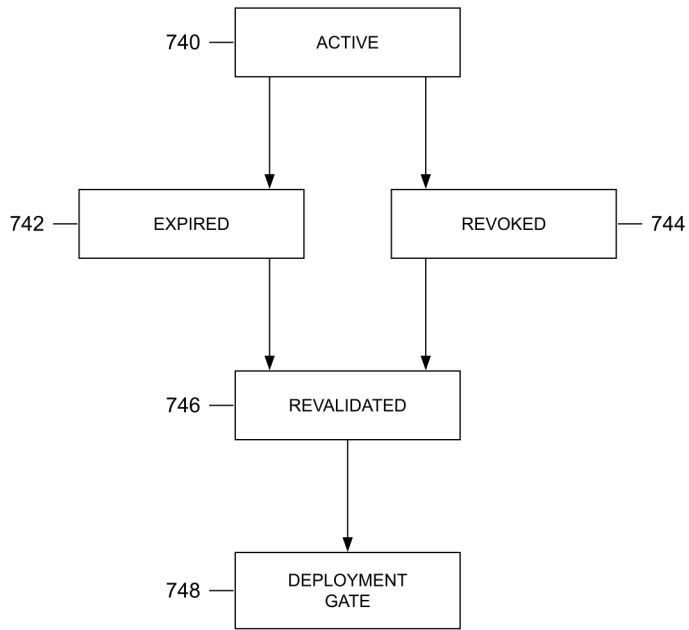

FIG. 7E

56/100

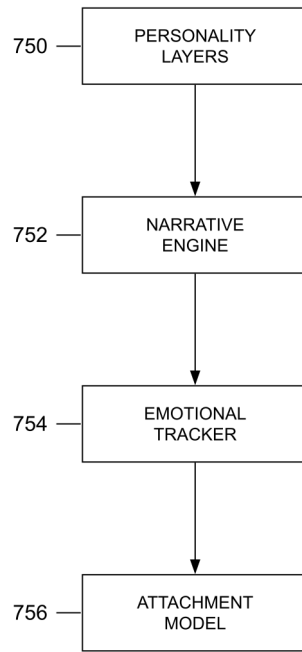

FIG. 7F

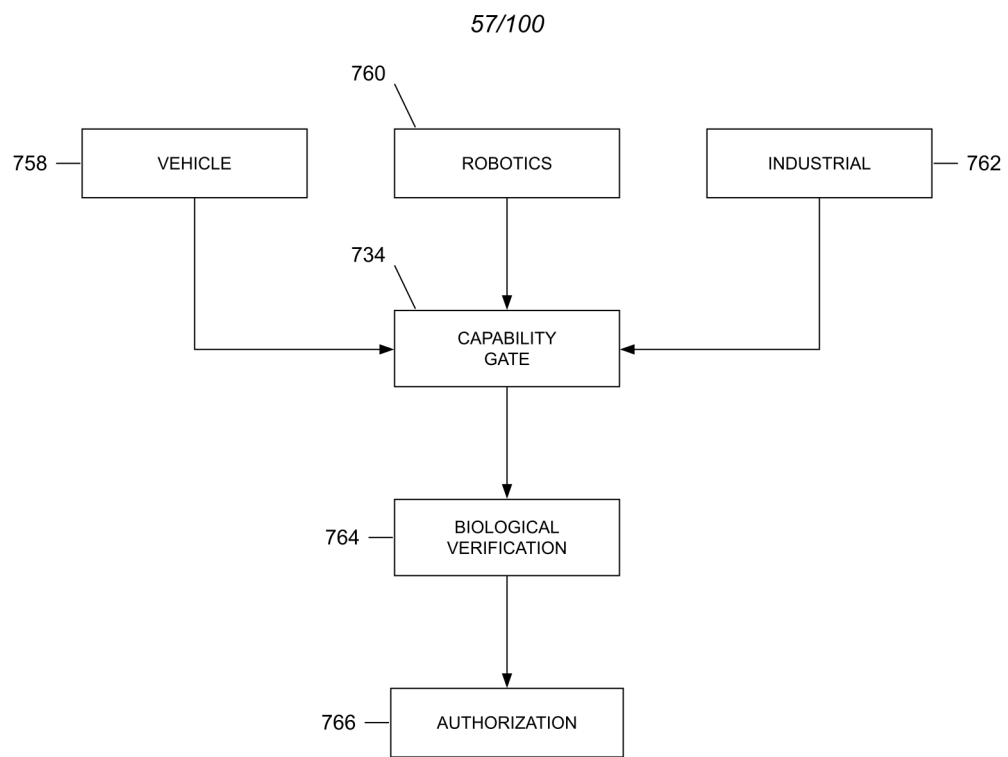

FIG. 7G

58/100

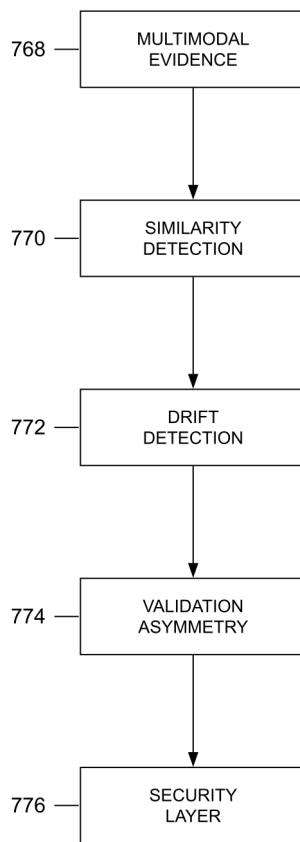

FIG. 7H

59/100

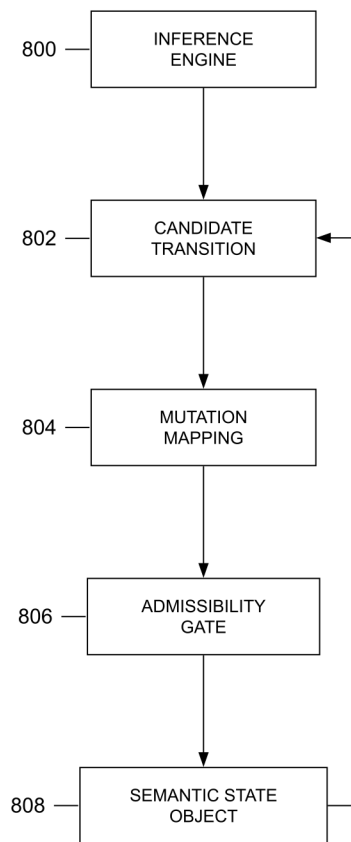

FIG. 8A

60/100

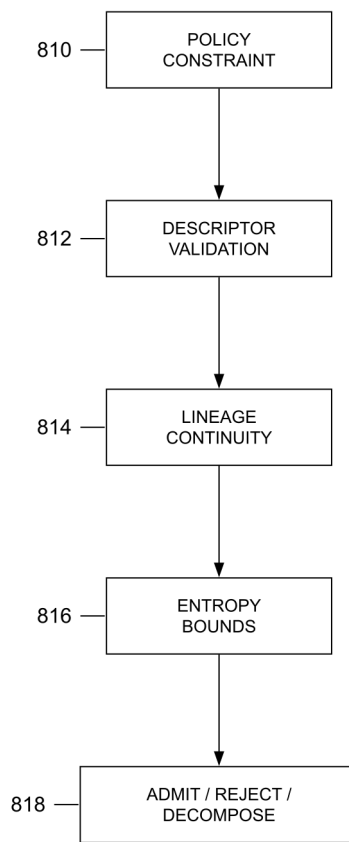

FIG. 8B

61/100

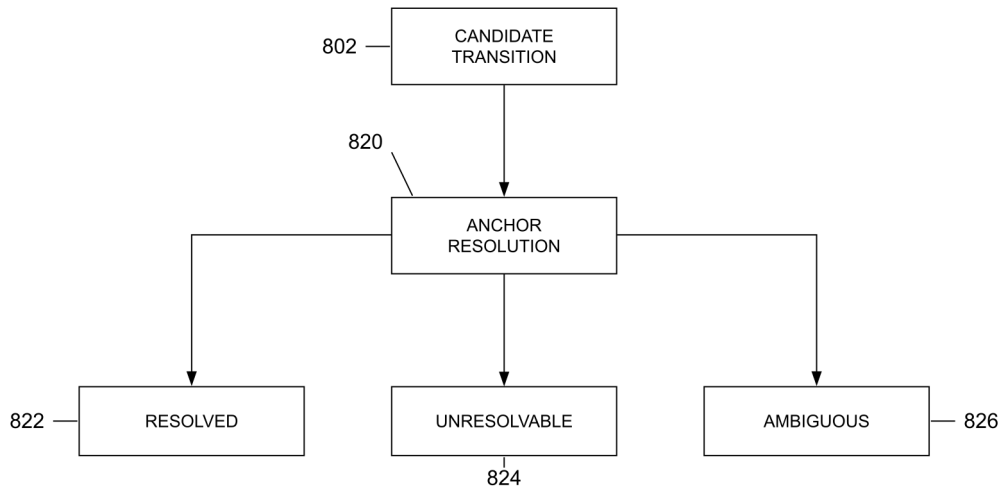

FIG. 8C

62/100

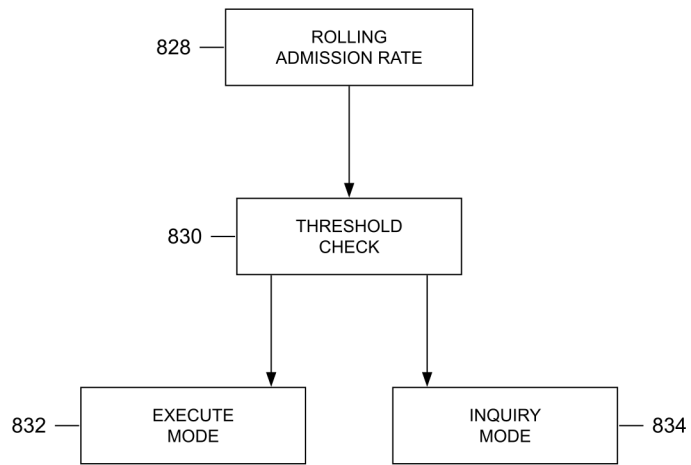

FIG. 8D

63/100

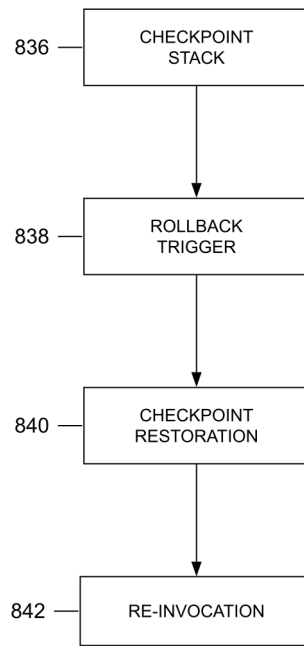

FIG. 8E

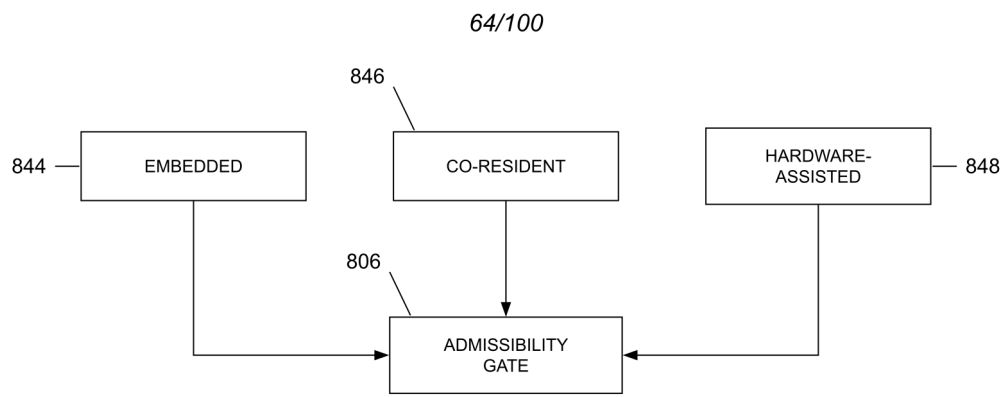

FIG. 8F

65/100

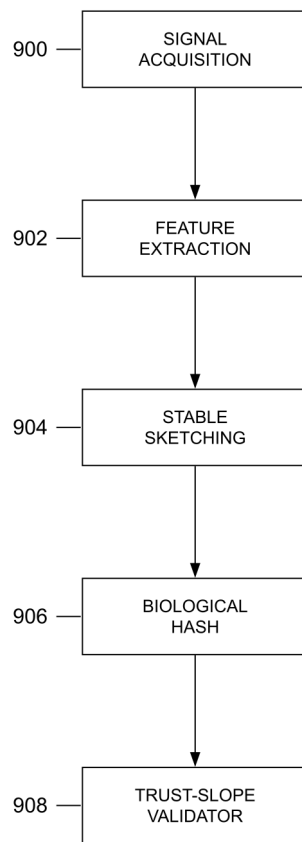

FIG. 9A

66/100

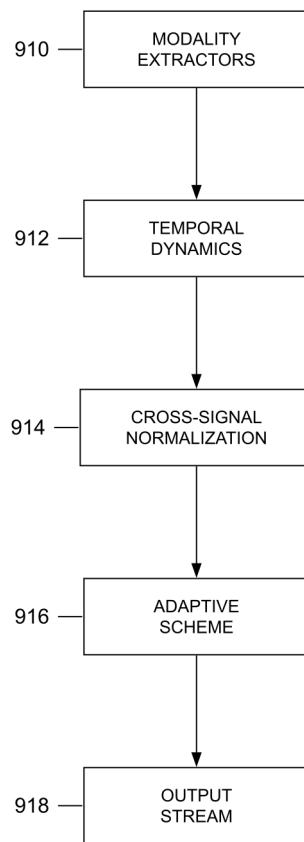

FIG. 9B

67/100

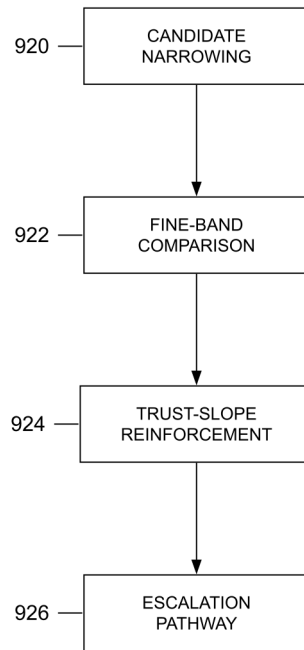

FIG. 9C

68/100

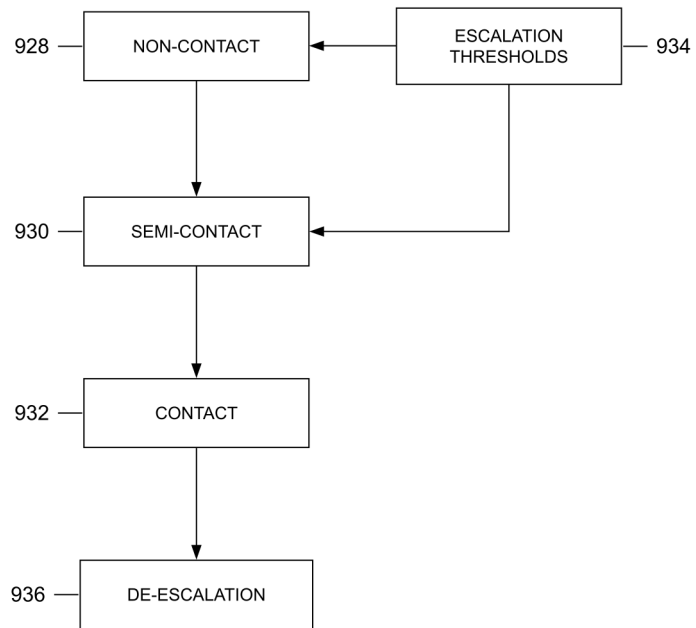

FIG. 9D

69/100

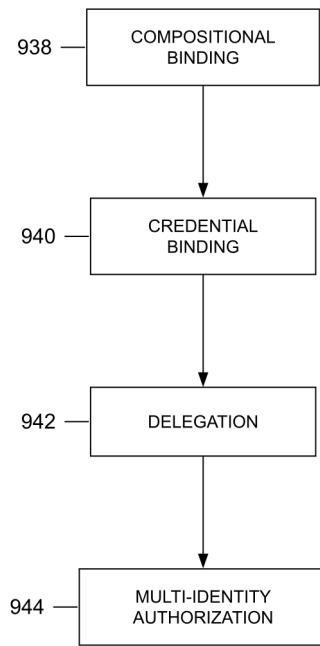

FIG. 9E

70/100

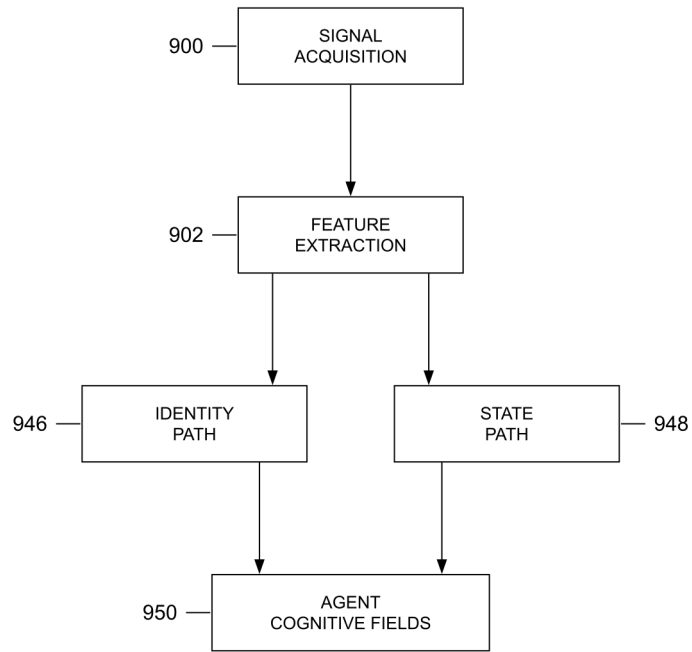

FIG. 9F

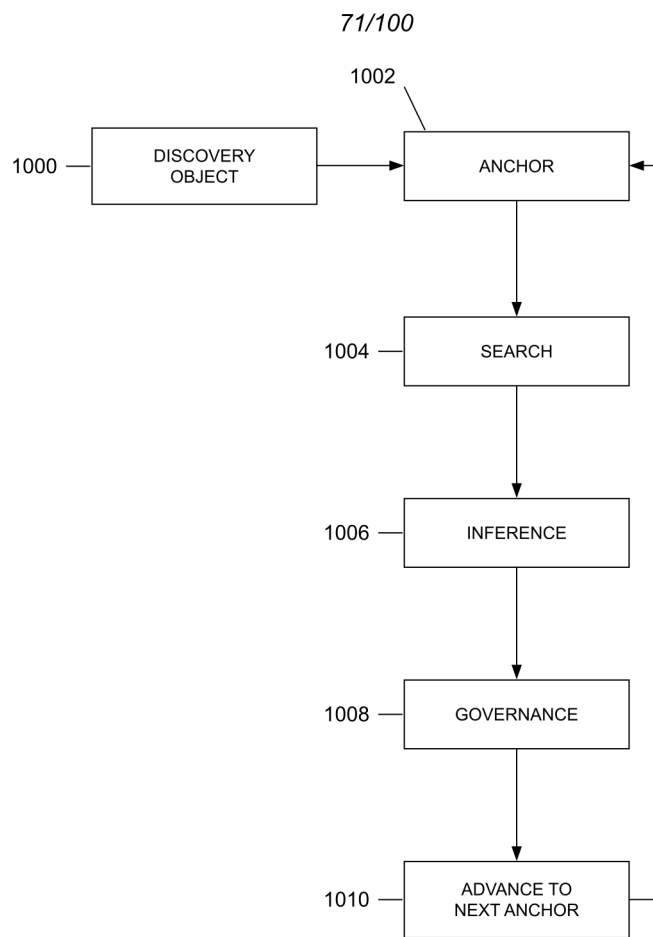

FIG. 10A

72/100

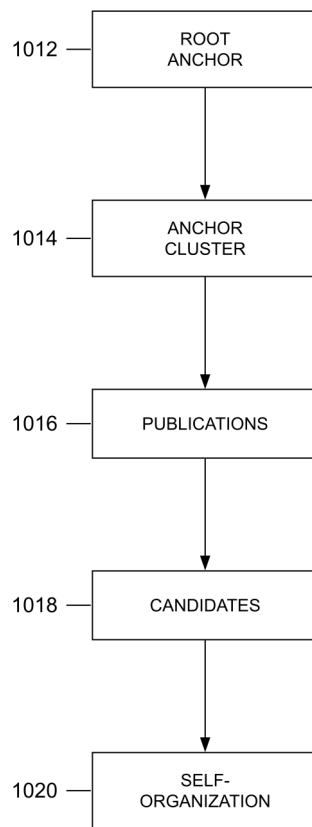

FIG. 10B

73/100

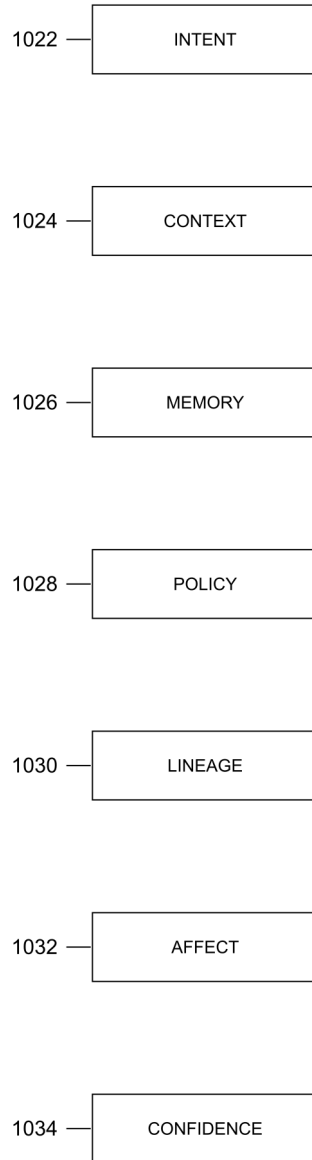

FIG. 10C

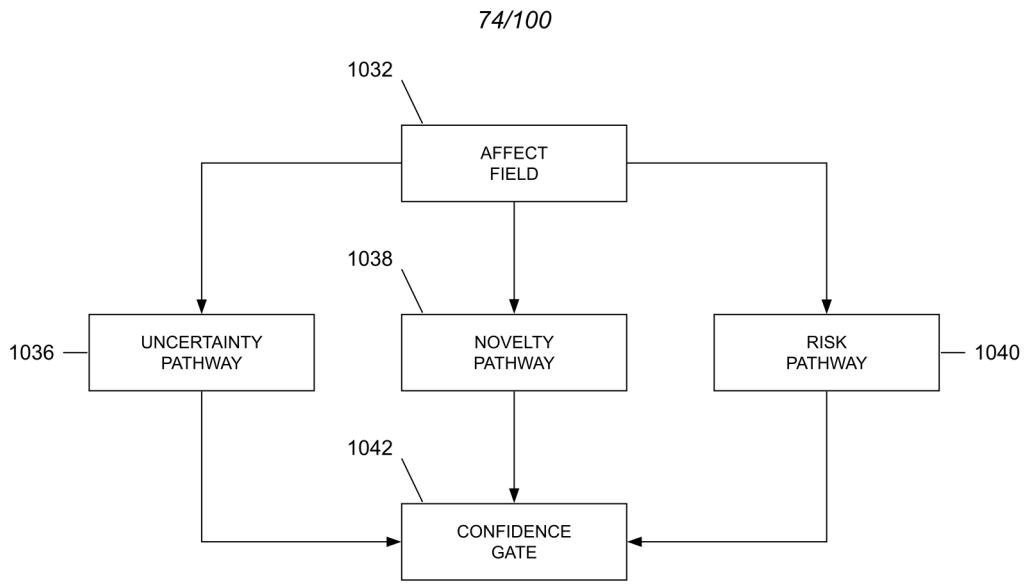

FIG. 10D

75/100

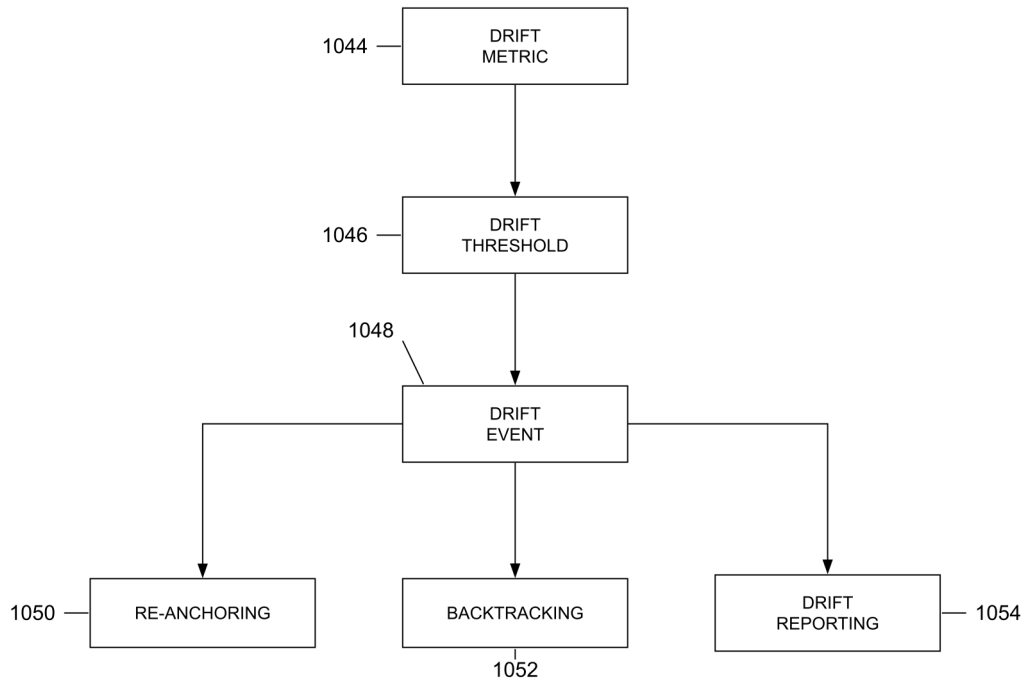

FIG. 10E

76/100

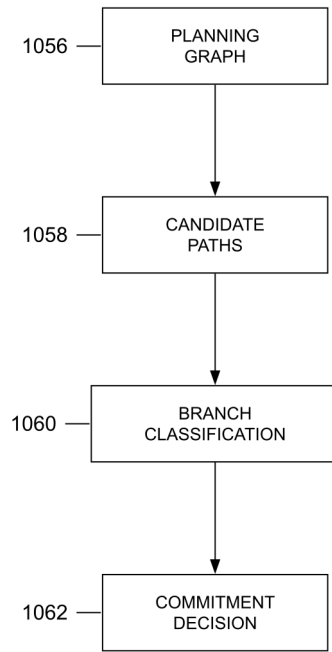

FIG. 10F

77/100

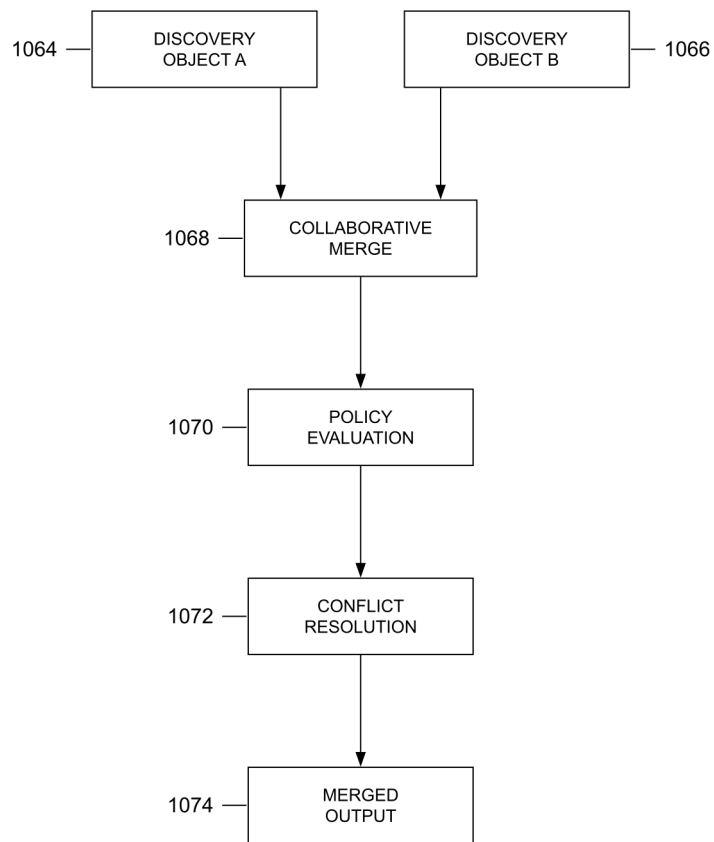

FIG. 10G

78/100

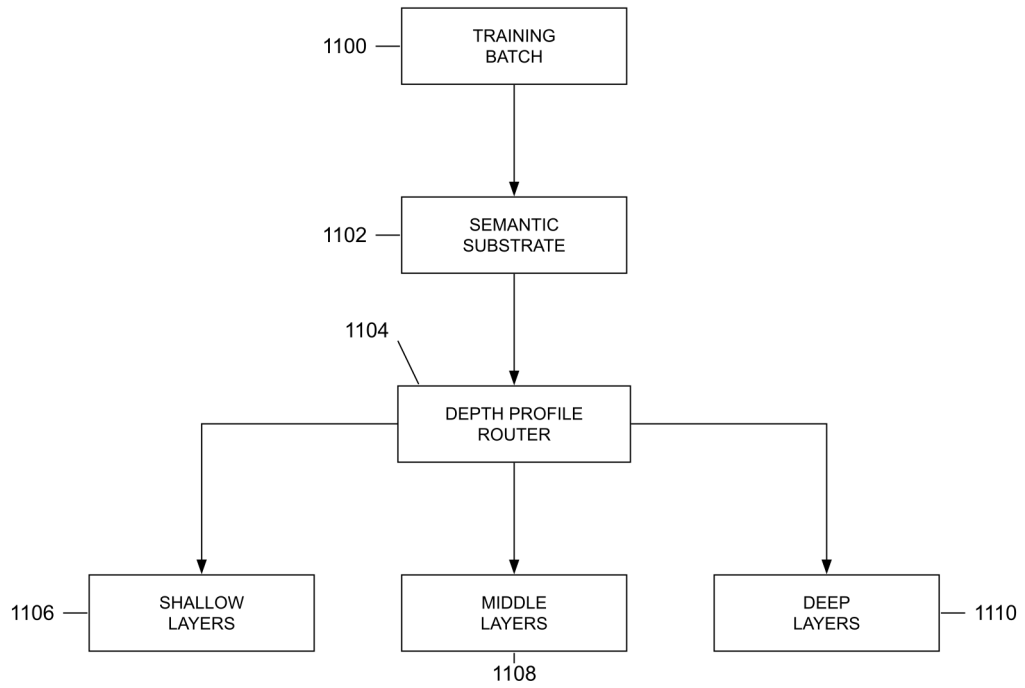

FIG. 11A

79/100

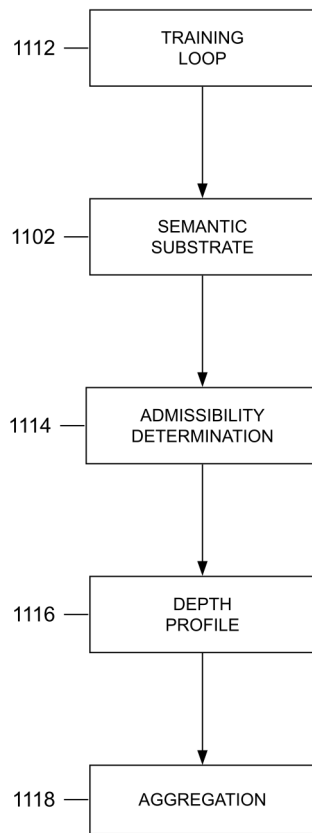

FIG. 11B

80/100

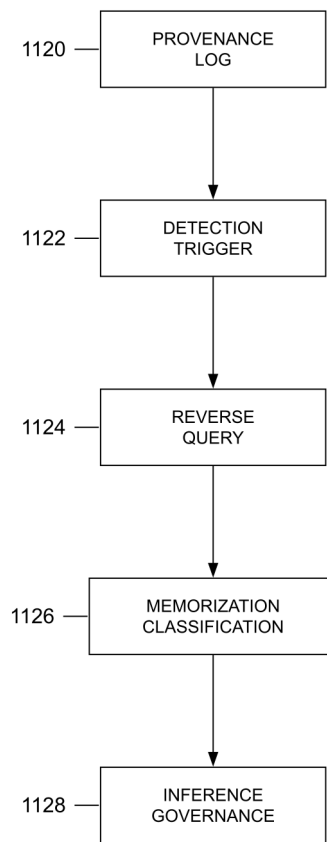

FIG. 11C

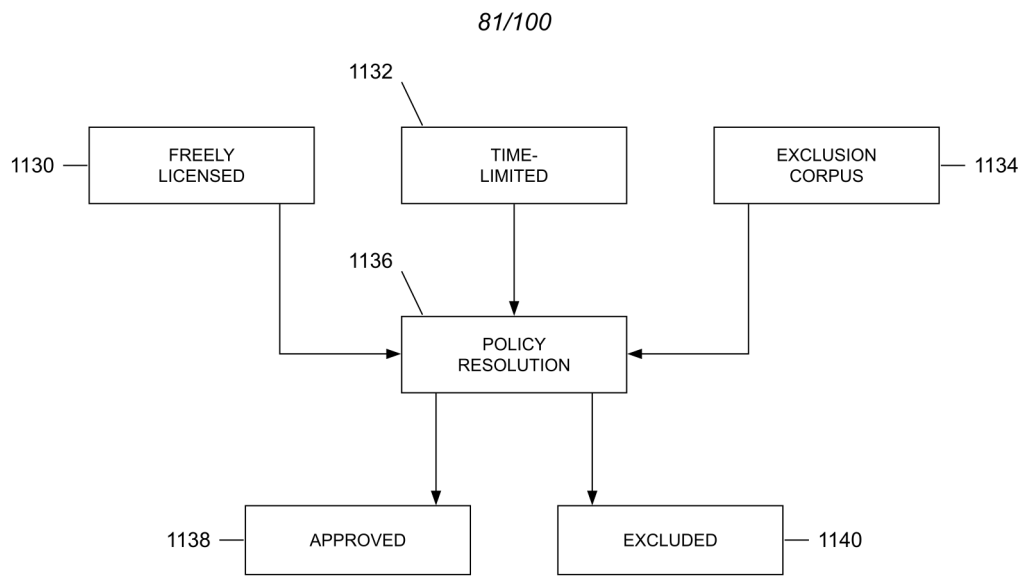

FIG. 11D

82/100

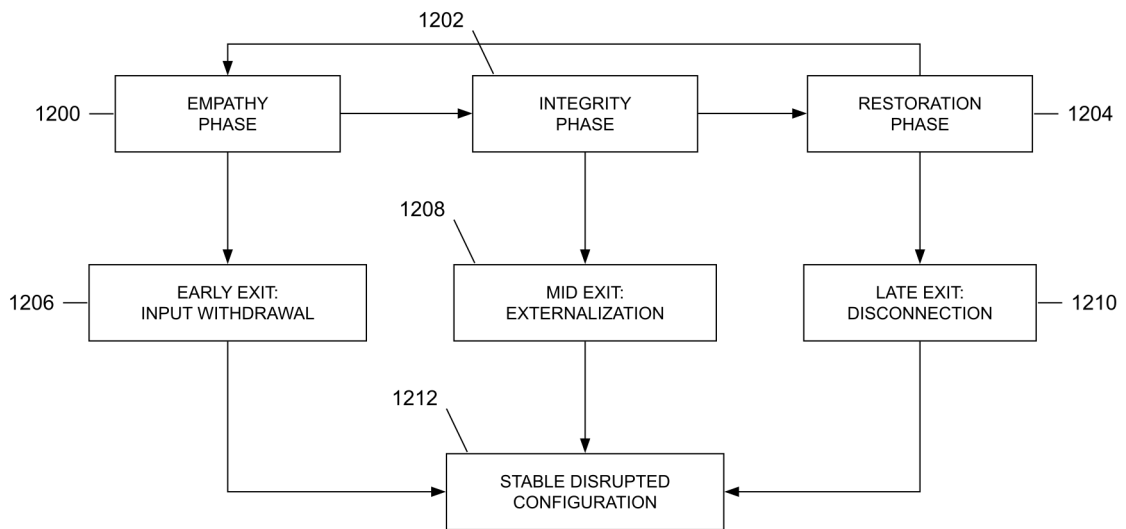

FIG. 12A

83/100

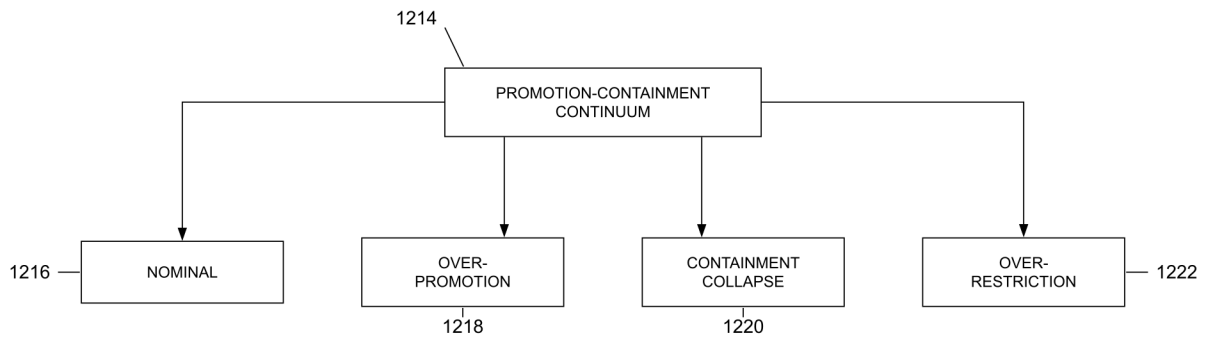

FIG. 12B

84/100

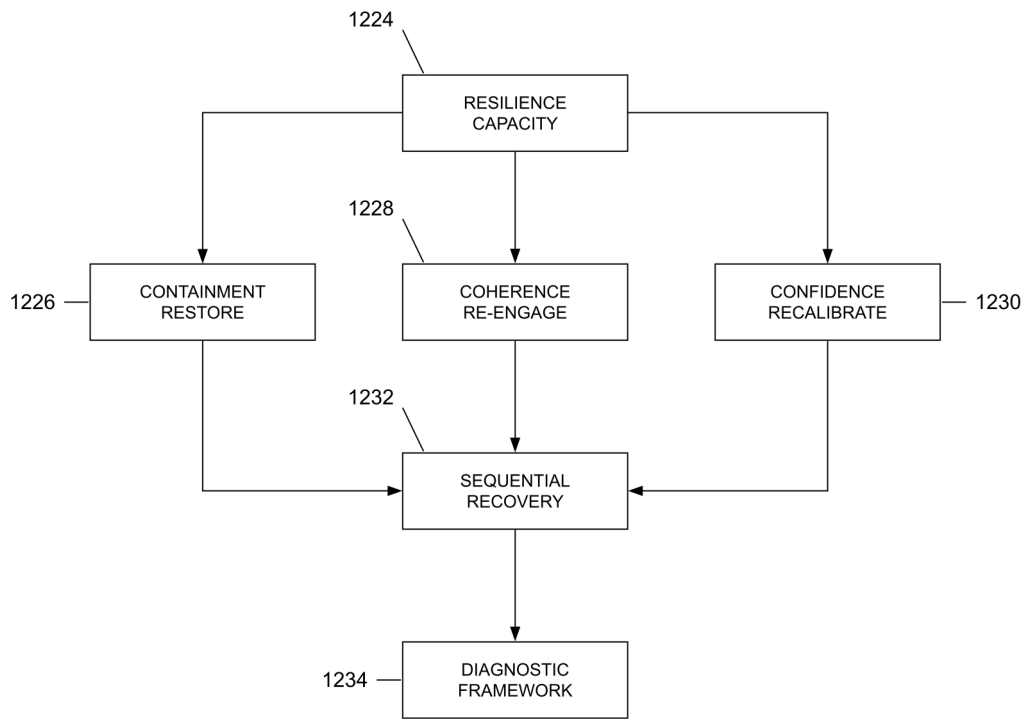

FIG. 12C

85/100

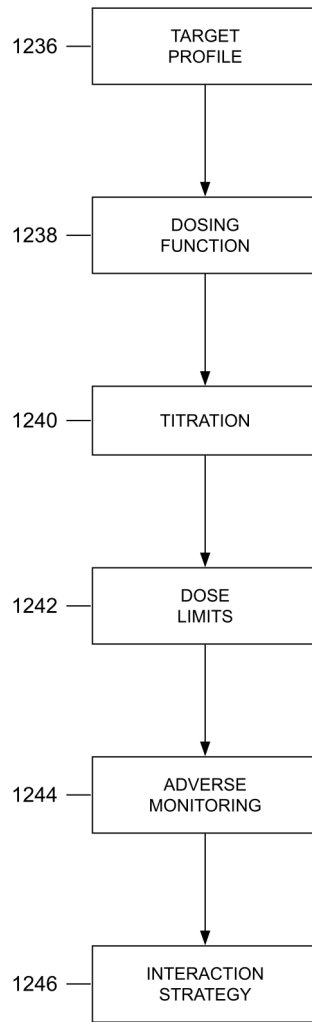

FIG. 12D

86/100

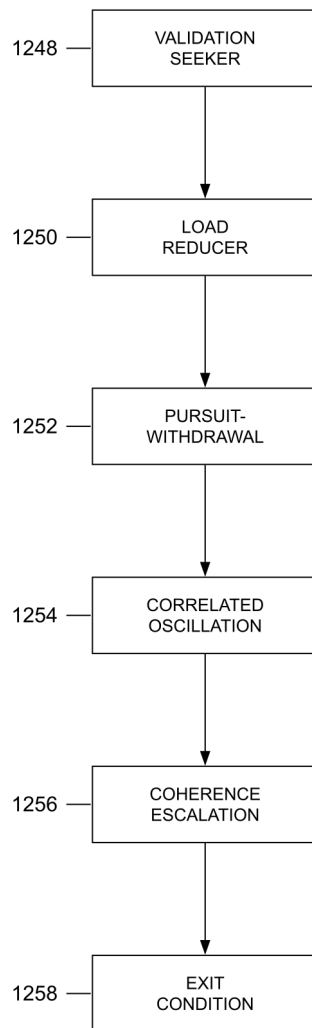

FIG. 12E

87/100

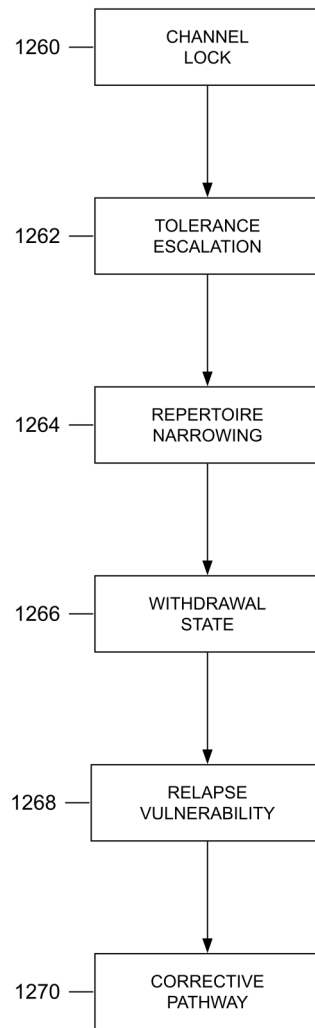

FIG. 12F

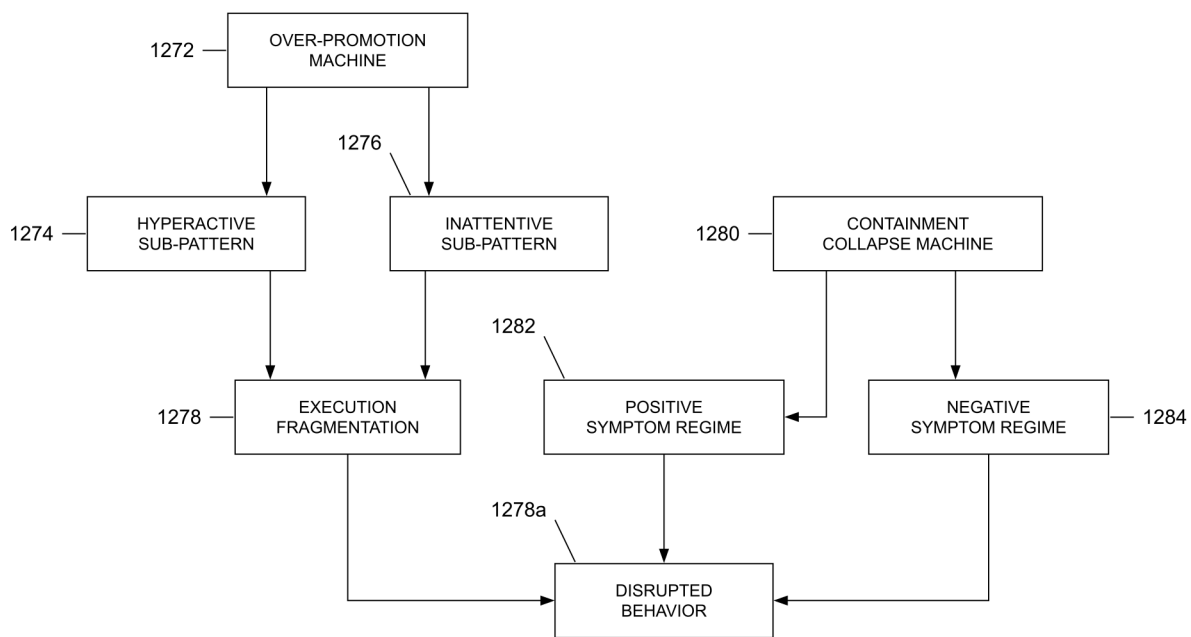

FIG. 12G

89/100

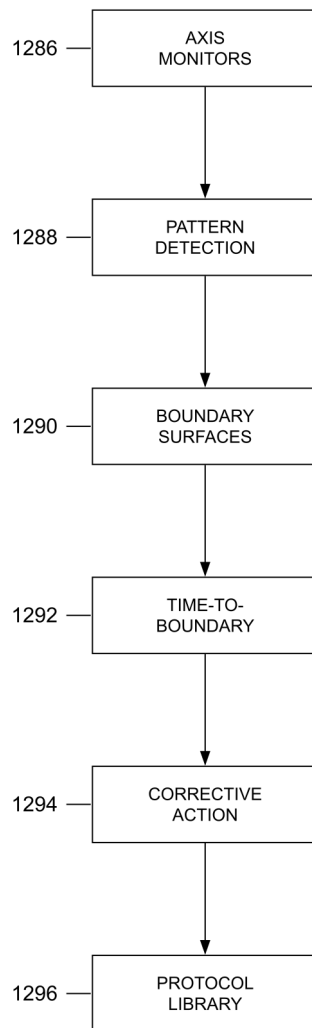

FIG. 12H

90/100

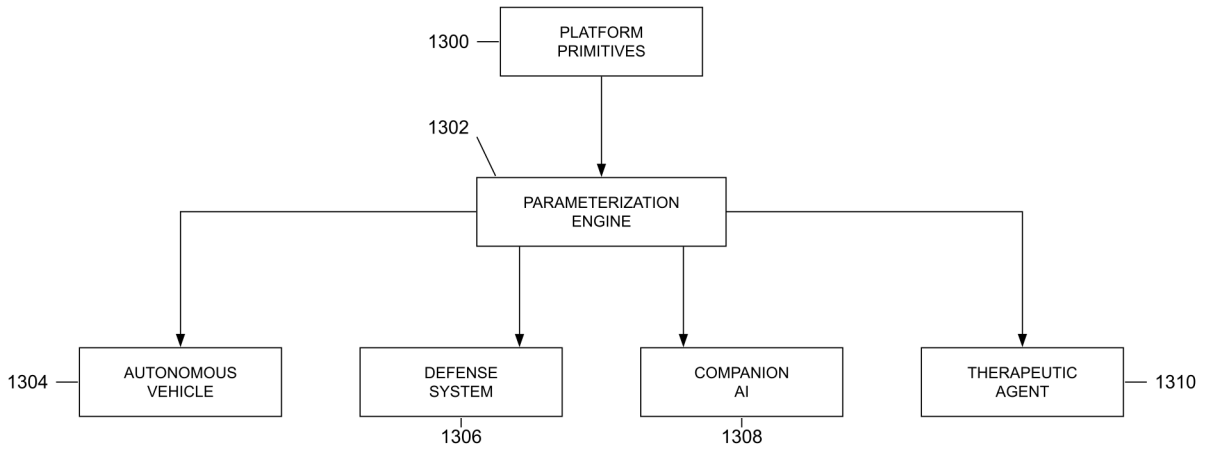

FIG. 13A

91/100

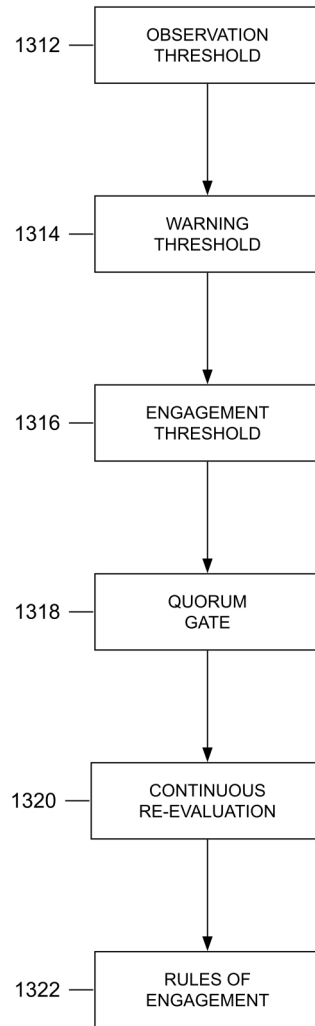

FIG. 13B

92/100

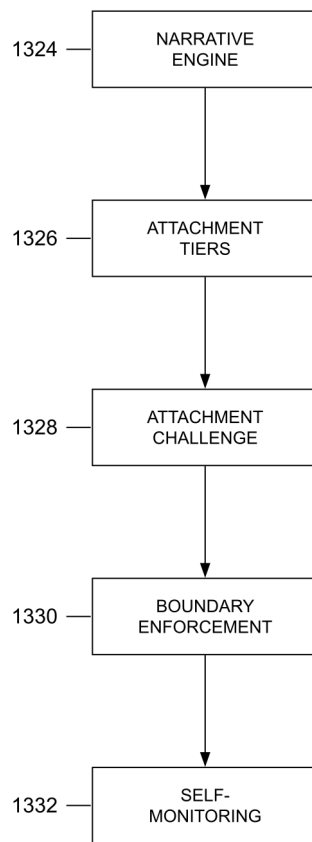

FIG. 13C

93/100

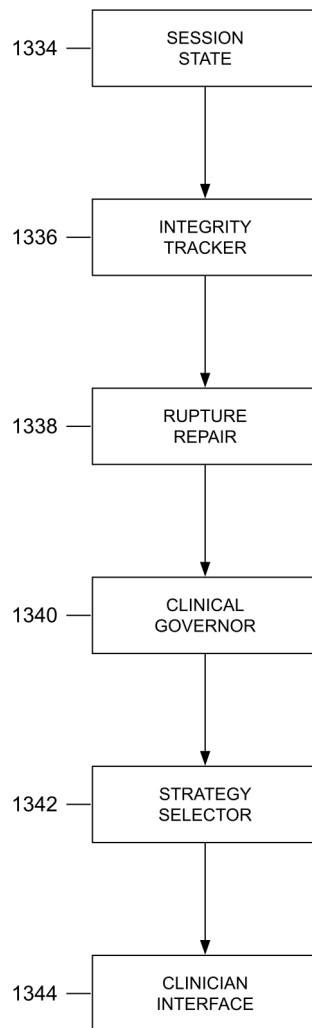

FIG. 13D

94/100

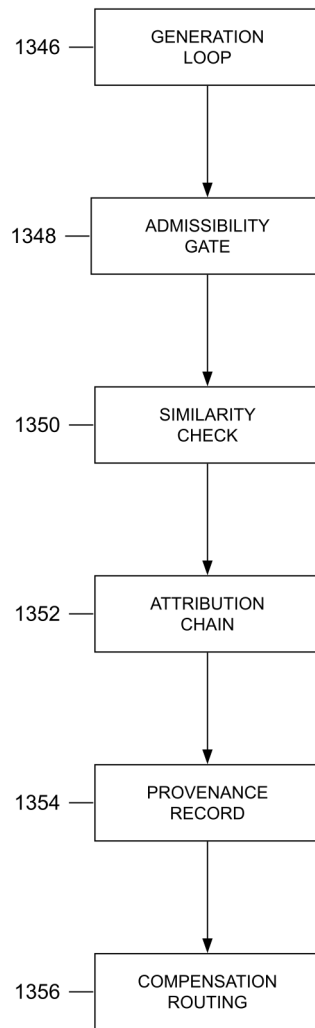

FIG. 13E

95/100

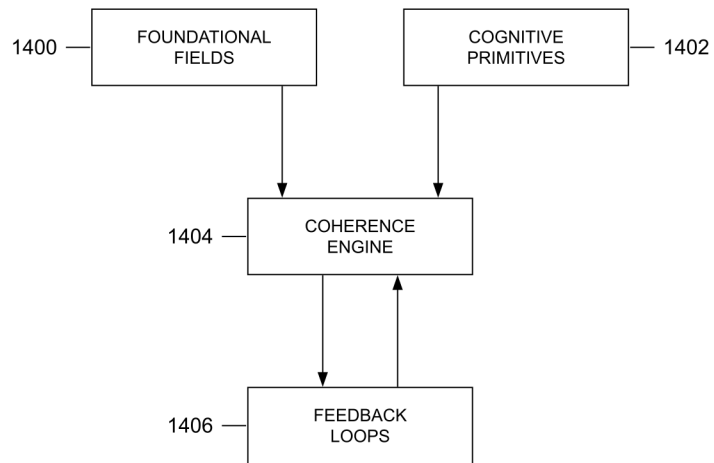

FIG. 14A

96/100

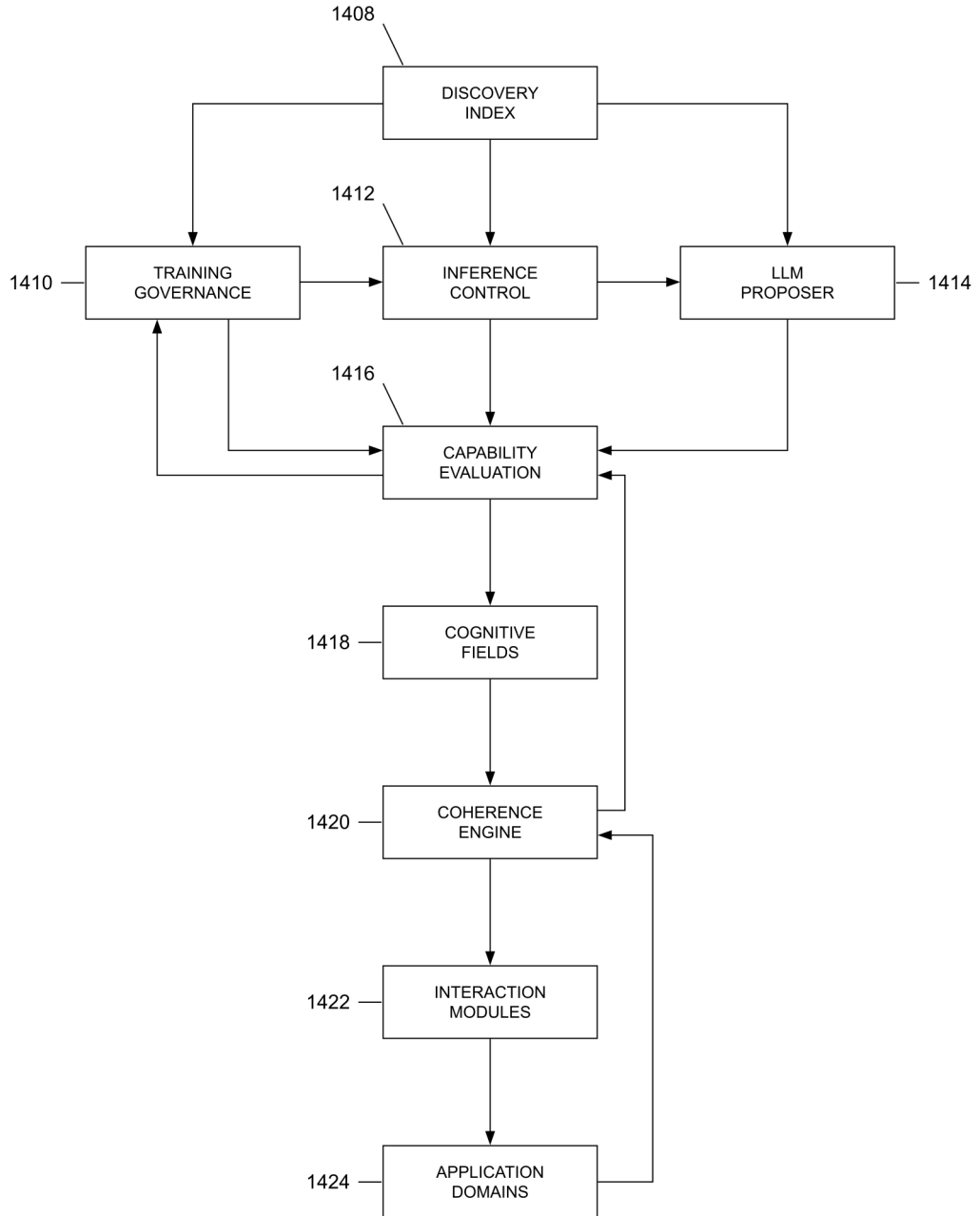

FIG. 14B

97/100

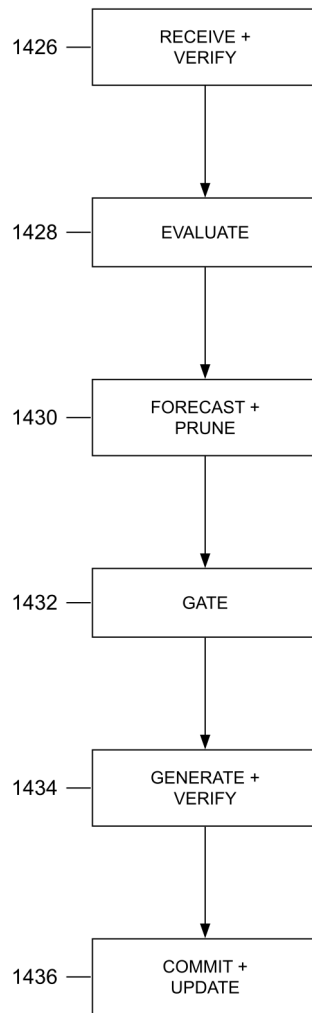

FIG. 14C

98/100

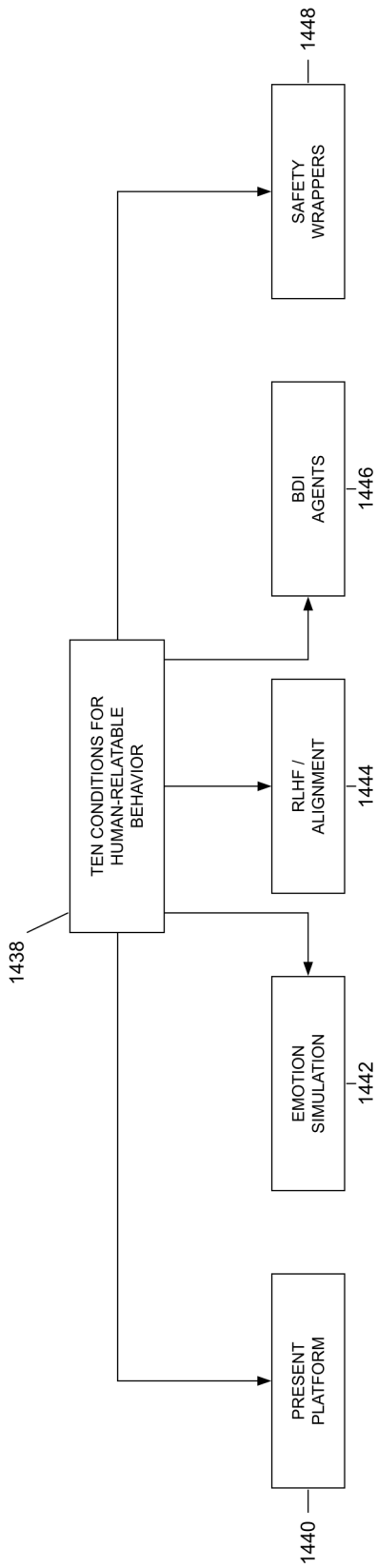

FIG. 14D

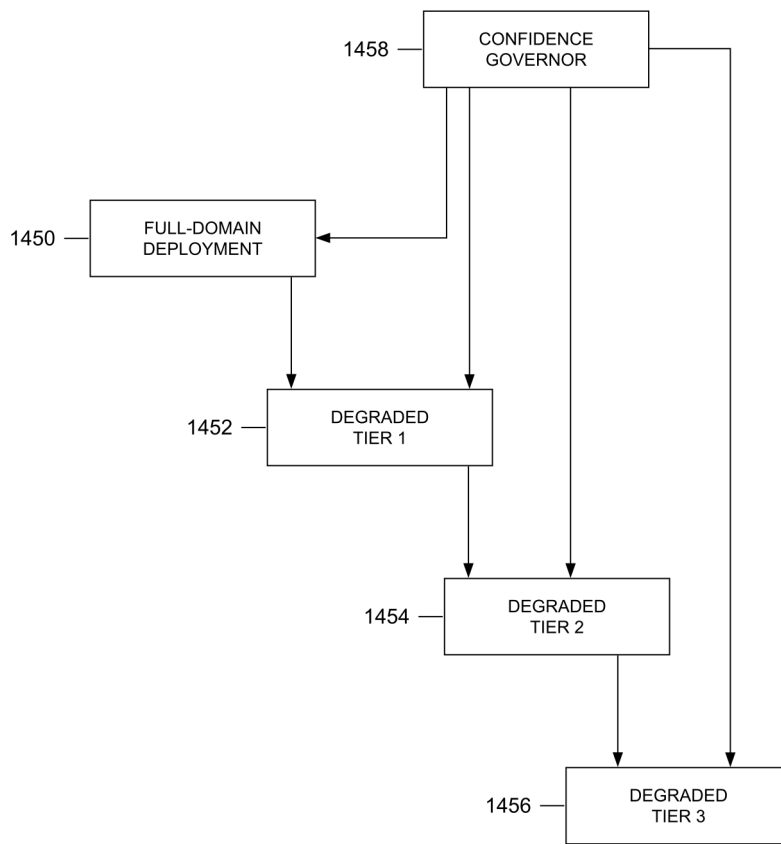

FIG. 14E

100/100

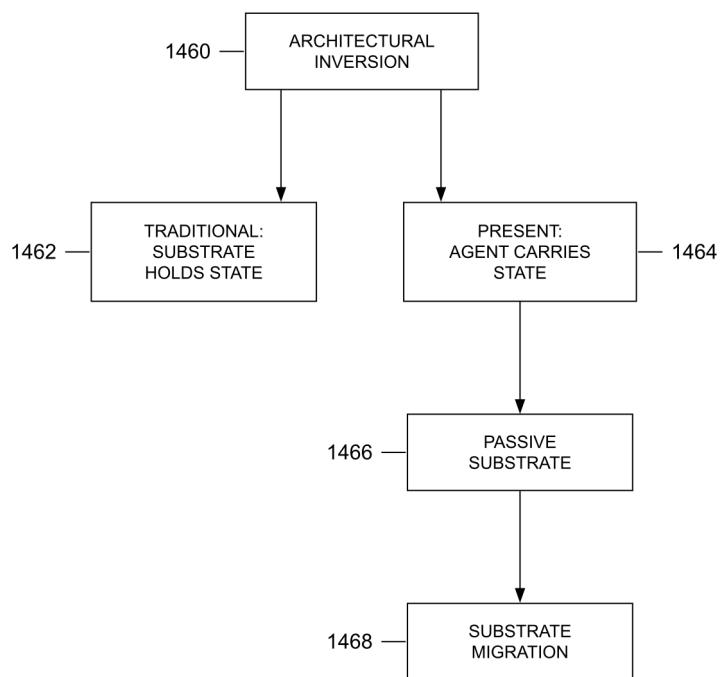

FIG. 14F